



LIGHTING FOREVER

# Technical Data Sheet

## Opto Interrupter

**ITR9909**

### ■ Features

- Fast response time
- High analytic
- Peak wavelength  $\lambda_p=940\text{nm}$
- High sensitivity
- Pb free
- This product itself will remain within RoHS compliant version.

### ■ Descriptions

The **ITR9909** consist of an infrared emitting diode and an NPN silicon phototransistor, encased side-by-side on converging optical axis in a black thermoplastic housing .

The phototransistor does not receive radiation from IR LED in normal situation, but when an object comes closer, the radiation is reflected by the object and phototransistor receives the more radiation as closer the object comes.

For additional component information, please refer to IR and PT.

### ■ Applications

- Mouse Copier
- Switch Scanner
- Floppy disk driver
- Non-contact Switching
- For Direct Board

### ■ Device Selection Guide

Device No.	Chip Material	LENS COLOR
IR	GaAlAs	Blue
PT	Silicon	Black

**Package Dimensions**

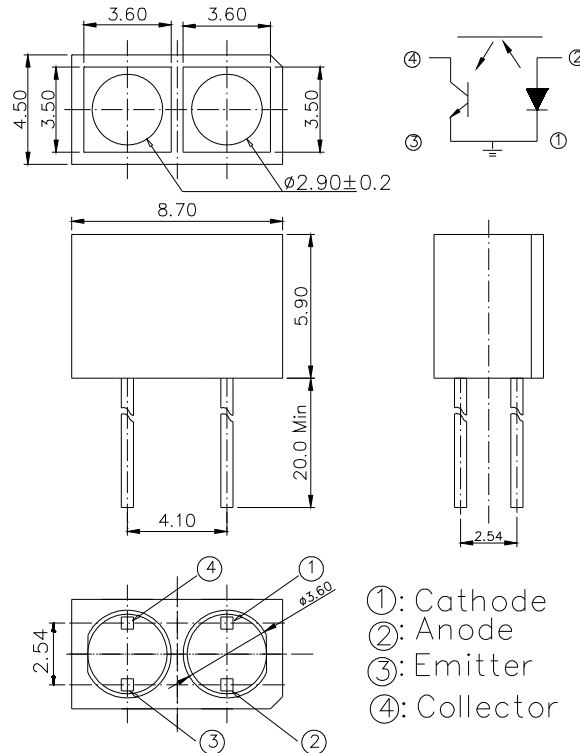

**Notes:**

1. All dimensions are in millimeters.
2. Tolerances unless dimensions  $\pm 0.25$  mm.
3. Lead spacing is measured where the lead emerge from the package.
4. Above specification may be changed without notice. EVERLIGHT will reserve authority on material change for above specification.
5. These specification sheets include materials protected under copyright of EVERLIGHT corporation . Please don't reproduce or cause anyone to reproduce them without EVERLIGHT's consent.
6. When using this product , please observe the absolute maximum ratings and the instructions for use outlined in these specification sheets. EVERIGHT assumes no responsibility for any damage resulting from use of the product which does not comply with the absolute maximum ratings and the instructions included in these specification sheets.

**Absolute Maximum Ratings (Ta=25°C)**

Parameter		Symbol	Ratings	Unit
Input	Power Dissipation at(or below) 25°C Free Air Temperature	Pd	100	mW
	Reverse Voltage	V <sub>R</sub>	5	V
	Forward Current	I <sub>F</sub>	50	mA
	Peak Forward Current (*1) Pulse width ≤ 100 μs, Duty cycle=1%	I <sub>FP</sub>	1	A
Output	Collector Power Dissipation	P <sub>C</sub>	100	mW
	Collector Current	I <sub>C</sub>	50	mA
	Collector-Emitter Voltage	B V <sub>CEO</sub>	30	V
	Emitter-Collector Voltage	B V <sub>ECO</sub>	5	V
Operating Temperature		T <sub>opr</sub>	-25~+85	°C
Storage Temperature		T <sub>stg</sub>	-40~+100	°C
Lead Soldering Temperature (*2) (1/16 inch form body for 5 seconds)		T <sub>sol</sub>	260	°C

(\*1)  $t_w=100 \mu \text{sec.}$ ,  $T=10 \text{msec.}$  (\*2)  $t=5 \text{Sec}$

**Electro-Optical Characteristics (Ta=25°C)**

Parameter		Symbol	Min.	Typ.	Max.	Unit	Conditions
Input	Forward Voltage	V <sub>F1</sub>	---	1.2	1.5	V	I <sub>F</sub> =20mA
		V <sub>F2</sub>	---	1.4	1.85		I <sub>F</sub> =100mA, tp=100 μs, tp/T=0.01
		V <sub>F3</sub>	---	2.6	4.0		I <sub>F</sub> =1A, tp=100 μs, tp/T=0.01
	Reverse Current	I <sub>R</sub>	---	---	10	μA	V <sub>R</sub> =5V
	Peak Wavelength	λ <sub>P</sub>	---	940	---	nm	I <sub>F</sub> =20mA
	View Angle	2θ <sub>1/2</sub>	---	60	---	Deg	I <sub>F</sub> =20mA
Output	Dark Current	I <sub>CEO</sub>	---	---	100	nA	V <sub>CE</sub> =20V, Ee=0mW/cm <sup>2</sup>
	C-E Saturation Voltage	V <sub>CE(sat)</sub>	---	---	0.4	V	I <sub>C</sub> =2mA , Ee=1mW/cm <sup>2</sup>
Transfer Characteristics	Collect Current	I <sub>C(ON)</sub>	0.2	---	---	mA	V <sub>CE</sub> =5V I <sub>F</sub> =20mA
	Rise time	t <sub>r</sub>	---	15	---	μsec	V <sub>CE</sub> =5V
	Fall time	t <sub>f</sub>	---	15	---	μsec	I <sub>C</sub> =1mA R <sub>L</sub> =1KΩ

**Typical Electrical/Optical/Characteristics Curves for IR**

Fig.1 Forward Current vs.

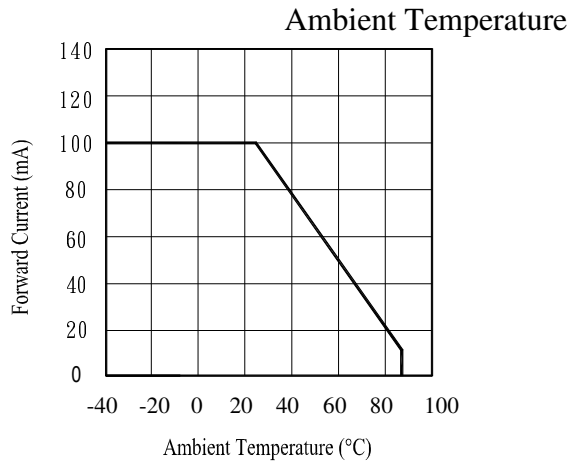

Fig.2 Spectral Distribution

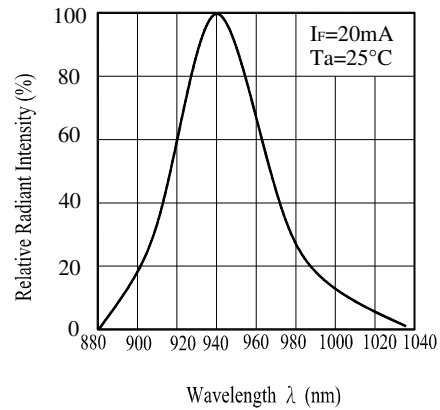

Fig.3 Radiant Intensity vs.

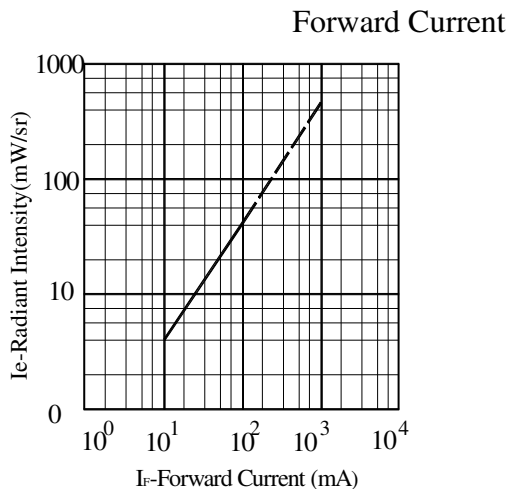

Fig.4 Relative Radiant Intensity vs.

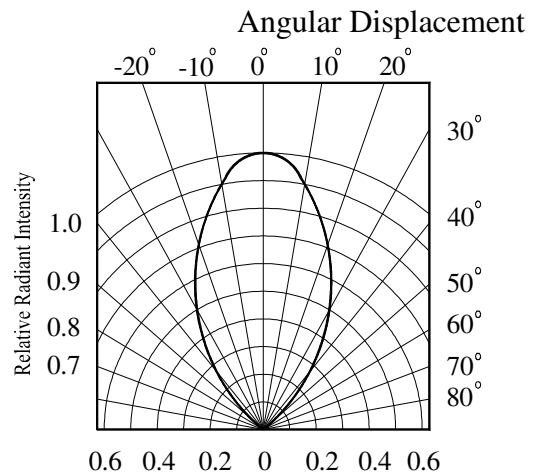

Fig.5 Forward Current vs.

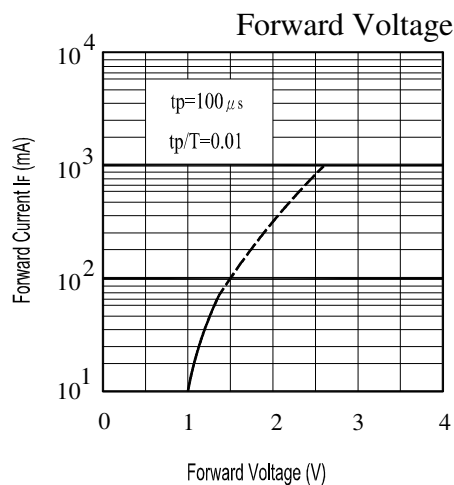
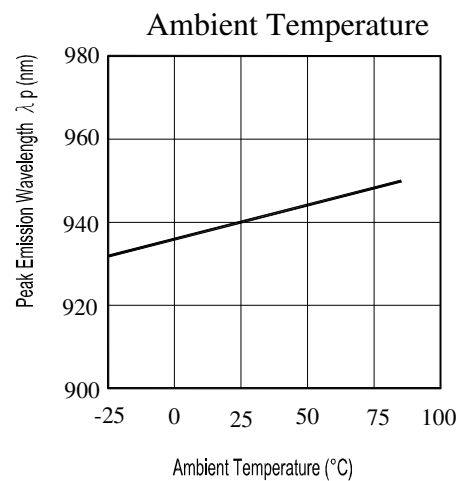

Fig.6 Peak Emission Wavelength



**Typical Electrical/Optical/Characteristics Curves for PT**

Fig.1 Collector Power Dissipation vs.

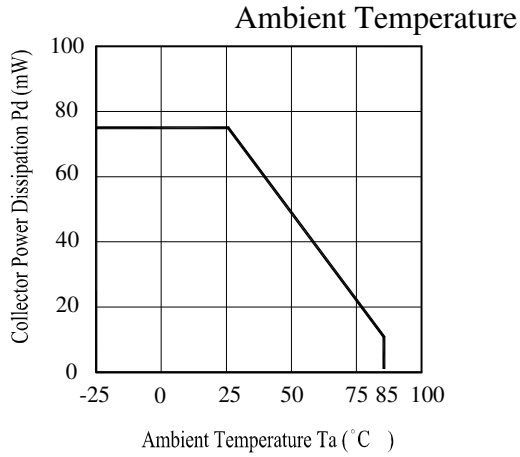

Fig.2 Spectral Sensitivity

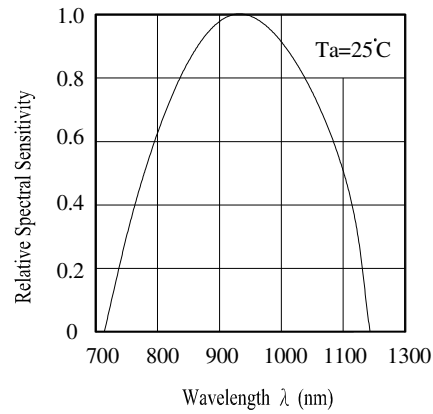

Fig.3 Relative Collector Current vs..

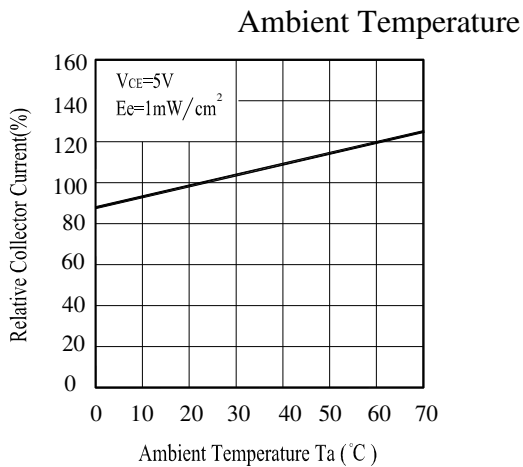

Fig.4 Collector Current vs.

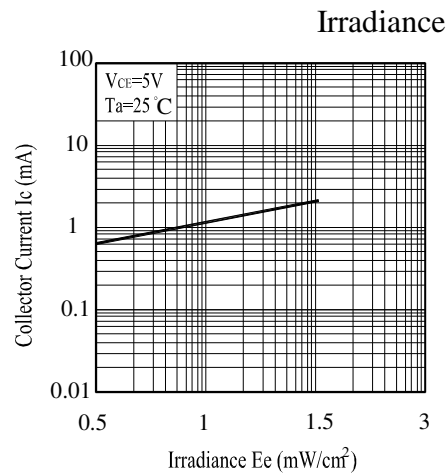

Fig.5 Collector Dark Current vs.

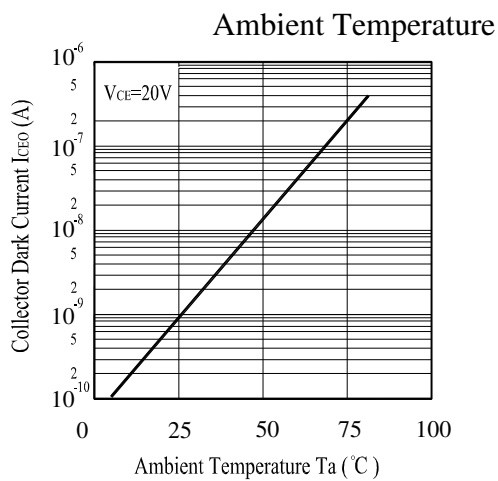
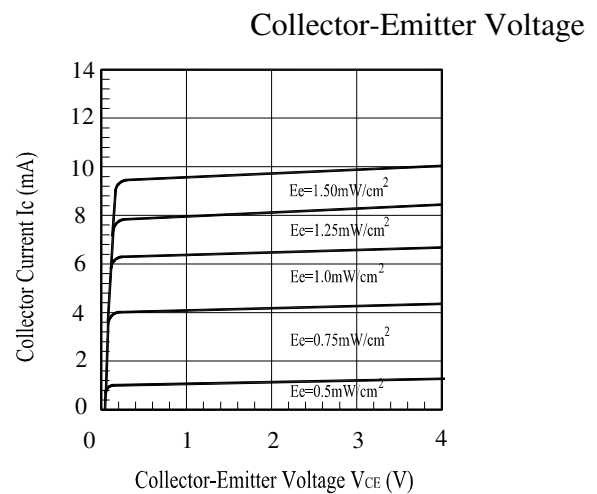

Fig.6 Collector Current vs.





**Reliability Test Item And Condition**

The reliability of products shall be satisfied with items listed below.

Confidence level : 90%

LTPD : 10%

NO.	Item	Test Condition	Test Hours/ Cycle	Sample Size	Failure Judgement Criteria	Ac/Re
1	Solder Heat	TEMP : 260°C ± 5 °C	10 sec	22 PCs	Attenuation of Light Current value > 20%	0/1
2	Temperature Cycle	H : +100°C    15 mins  5 min L : -40°C    15 min	300 cycle	22 PCs		0/1
3	Thermal Shock	H : +100°C    5 min  10 sec L : -10°C    5 min	300 cycle	22 PCs		0/1
4	High Temperature Storage	TEMP. : +100°C	1000 hrs	22 PCs		0/1
5	Low Temperature Storage	TEMP. : -40°C	1000 hrs	22 PCs		0/1
6	DC Operating Life	V <sub>CE</sub> =5V I <sub>F</sub> =20mA	1000 hrs	22 PCs		0/1
7	High Temperature / High Humidity	85°C / 85% R.H.	1000 hrs	22 PCs		0/1

■ **Packing Quantity Specification**

150 pcs/1bag , 5 bags/1box , 10 boxes/1carton

■ **Label Form Specification**

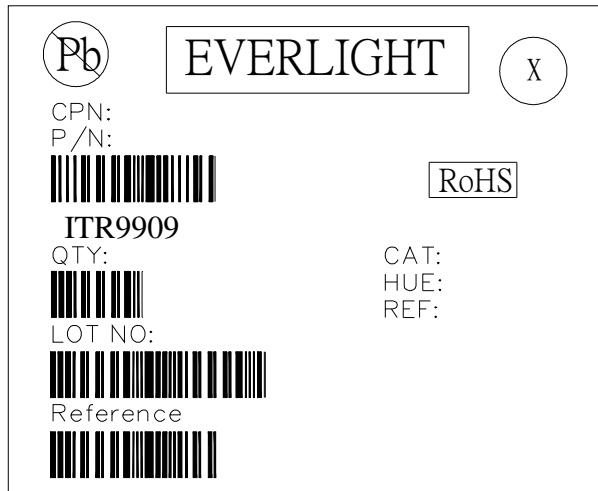

CPN: Customer's Production Number  
P/N : Production Number  
QTY: Packing Quantity  
CAT: Ranks  
HUE: Peak Wavelength  
REF: Reference  
LOT No: Lot Number  
X: Month  
Reference: Identify Label Number

■ **Notes**

1. Above specification may be changed without notice. EVERLIGHT will reserve authority on material change for above specification.
2. When using this product, please observe the absolute maximum ratings and the instructions for using outlined in these specification sheets. EVERLIGHT assumes no responsibility for any damage resulting from use of the product which does not comply with the absolute maximum ratings and the instructions included in these specification sheets.
3. These specification sheets include materials protected under copyright of EVERLIGHT corporation. Please don't reproduce or cause anyone to reproduce them without EVERLIGHT's consent.

**EVERLIGHT ELECTRONICS CO., LTD.**  
Office: No 25, Lane 76, Sec 3, Chung Yang Rd,  
Tucheng, Taipei 236, Taiwan, R.O.C

Tel: 886-2-2267-2000, 2267-9936  
Fax: 886-2267-6244, 2267-6189, 2267-6306  
<http://www.everlight.com>