



Interrupter

MODEL NO : ITR20001/T24

■ Features :

- Fast response time
- High analytic
- Cut-off visible wavelength $\lambda_p=840\text{nm}$
- High sensitivity

■ Description :

The **ITR20001/T24** consist of an infrared emitting diode and an NPN silicon phototransistor, encased side-by-side on converging optical axis in a black thermoplastic housing. The phototransistor could not receive radiation from the IRED. This is the normal situation. But when an reflecting object close to ITR, phototransistor receives the reflecting radiation. For additional component information, please refer to **IR2424-3C** and **PT2424-6B**.

■ Applications :

- Copier
- Switch Scanner
- Non-contact Switching
- For Direct PC Board

PART NO.	CHIP	LENS COLOR
	MATERIAL	
IR	GaAlAs	Water clear
PT	Silicon	Black

Interrupter

MODEL NO : ITR20001/T24

■ Package Dimension :

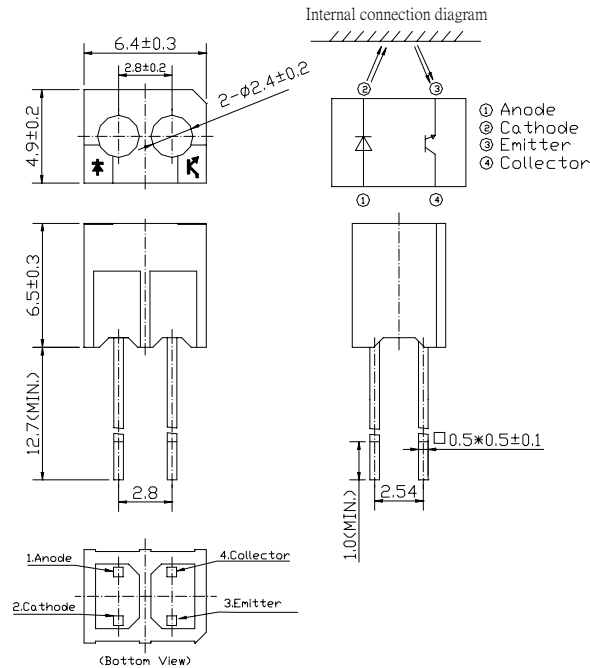

■ Notes :

1. All dimensions are in millimeter.
2. General tolerance: ± 0.3 mm
3. Lead spacing is measured where the lead emerge from the package.
4. Above specification may be changed without notice. EVERLIGHT will reserve authority on material change for above specification.
5. These specification sheets include materials protected under copyright of EVERLIGHT corporation . Please don't reproduce or cause anyone to reproduce them without EVERLIGHT's consent.
6. When using this product , please observe the absolute maximum ratings and the instructions for use outlined in these specification sheets. EVERIGHT assumes no responsibility for any damage resulting from use of the product which does not comply with the absolute maximum ratings and the instructions included in these specification sheets.



Interrupter

MODEL NO : ITR20001/T24

■ Absolute Maximum Ratings at T_A = 25°C

Parameter		Symbol	Rating	Unit
Input	Power Dissipation	P _D	100	mW
	Reverse Voltage	V _R	5	V
	Forward Current	I _F	50	mA
	Peak Forward Current(*1)	I _{FP}	1	A
Output	Collect Power Dissipation	P _C	75	mW
	Collect Current	I _C	20	mA
	Collector-Emitter Voltage	V _{CE}	30	V
	Emitter-Collector Voltage	V _{EC}	5	V
Operating Temperature		Topr	-25~+85	°C
Storage Temperature		Tstg	-40~+85	°C
Soldering Temperature(*2)		Tsol	260	°C

(*1) Pause width= 100 μs, Duty Cycle=1% (*2) t=5 secs

■ Electronic Optical Characteristics at T_A = 25°C:

Parameter		Symbol	Min.	Typ.	Max.	Unit	Condition
Input	Forward Voltage	V _{F1}	-	1.2	1.5	V	I _F =20mA
		V _{F2}	-	1.4	1.85		I _F =100mA, tp=100 μs, tp/T=0.01
		V _{F3}	-	2.6	4.0		I _F =1A, tp=100 μs, tp/T=0.01
	Reverse Current	I _R	-	-	10	μA	V _R =5V
	Peak Wavelength	λ _P	-	940	-	nm	I _F =20mA
	View Angle	2θ 1/2	-	35	-	Deg	I _F =20mA
Output	Dark Current	I _{CEO}	-	-	100	nA	V _{CE} =5V, Ee=0mW/cm ²
	C-E Saturation Voltage	V _{CE(sat)}	-	-	0.4	V	I _C =0.04mA, I _F =40mA
Collector Current(*3)		I _{C(ON)}	800	-	4000	uA	V _{CE} =5V, I _F =20mA
		I _{C(OFF)}	-	-	2	μA	
Response Time	Rise Time	t _R	-	25	-	μs	V _{CE} =5V, I _C =100 μA , R _L =100Ω
	Fall Time	t _F	-	25	-	μs	

(*3) I_{C(on)} at the testing condition—with reflector in 5mm away,

I_{C(off)} at the testing condition—without reflector and external light less than 10 Lux at the module surface.



Interrupter

MODEL NO : ITR20001/T24

■ Typical Electrical/Optical/Characteristics Curves For IR

Fig. 1 Forward Current vs. Ambient Temperature

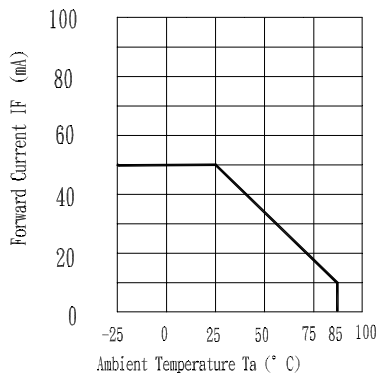

Fig. 2 Spectral Distribution

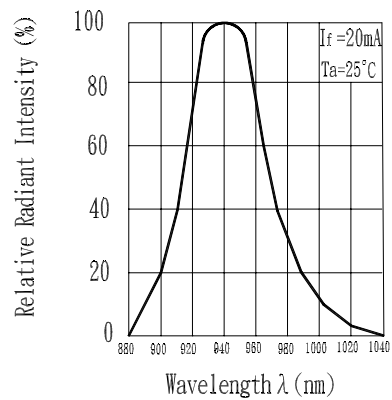

Fig. 3 Peak Emission Wavelength vs. Ambient Temperature

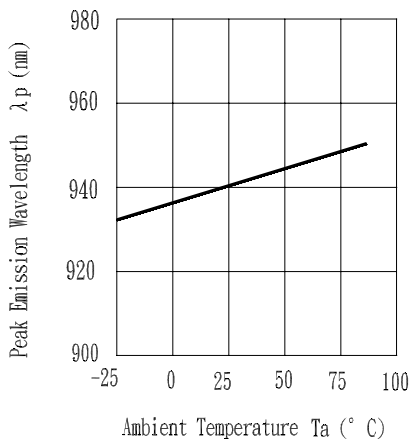

Fig. 4 Forward Current vs. Forward Voltage

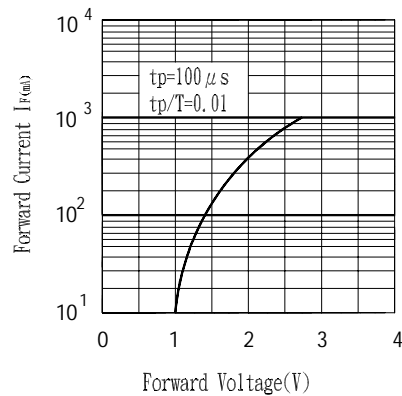

Fig. 5 Relative Intensity vs. Forward Current

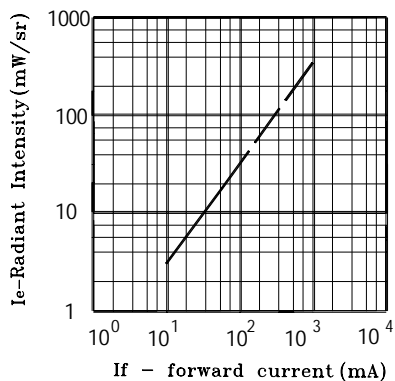
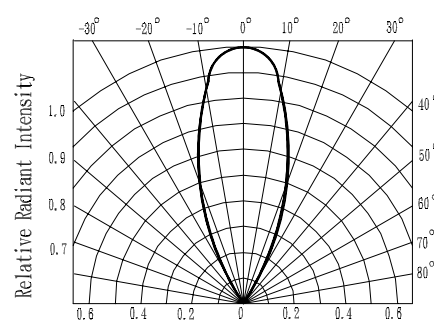

Fig. 6 Relative Radiant Intensity vs. Angular Displacement





Interrupter

MODEL NO : ITR20001/T24

■ Typical Electrical/Optical/Characteristics Curves For PT

Fig.1 Collector Power Dissipation vs. Ambient Temperature

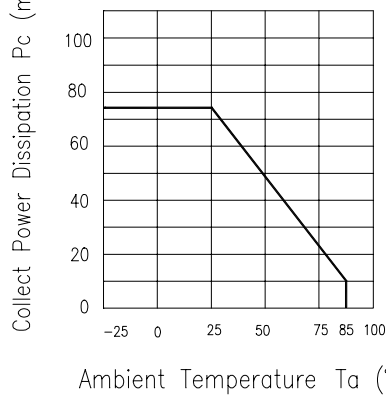

Fig.2 Collector Dark Current vs. Ambient Temperature

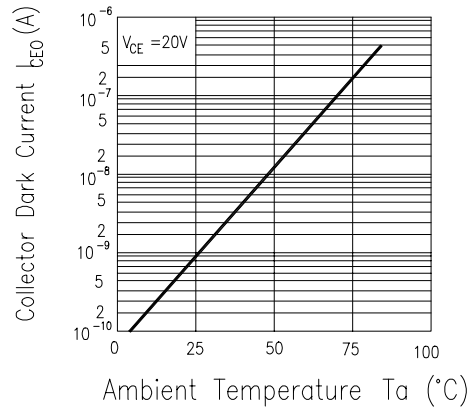

Fig. 3 Relative Collector Current vs. Ambient Temperature

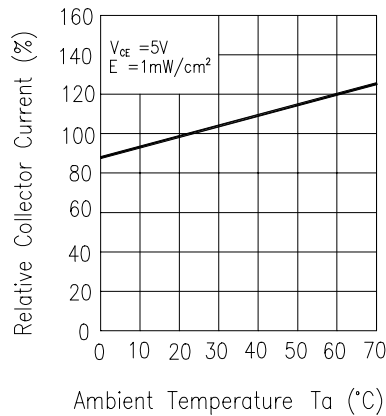

Fig.4 Collector Current vs. Irradiance

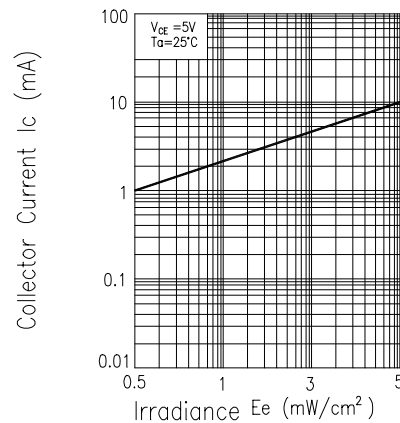

Fig.5 Spectral Sensitivity

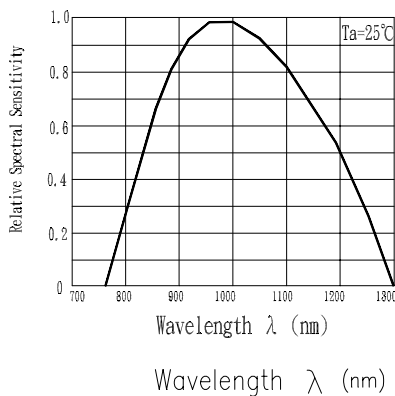
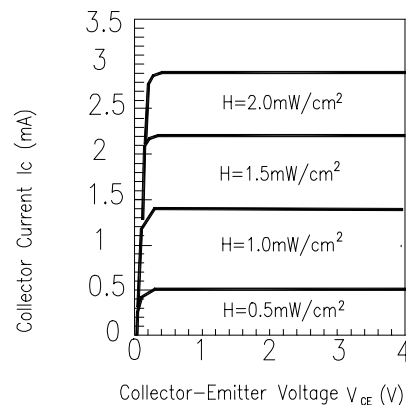

Fig.6 Collector Current vs. Collector-Emitter Voltage





Interrupter

MODEL NO : ITR20001/T24

■ Typical Electrical/Optical/Characteristics Curves For ITR

Relative output current vs. detecting distance

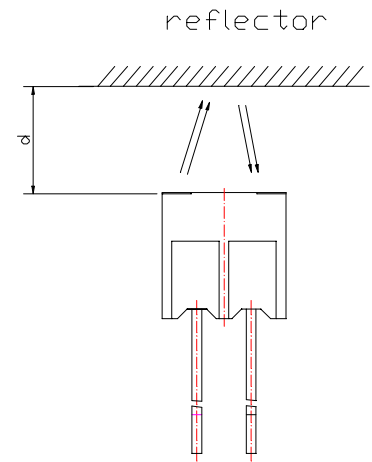
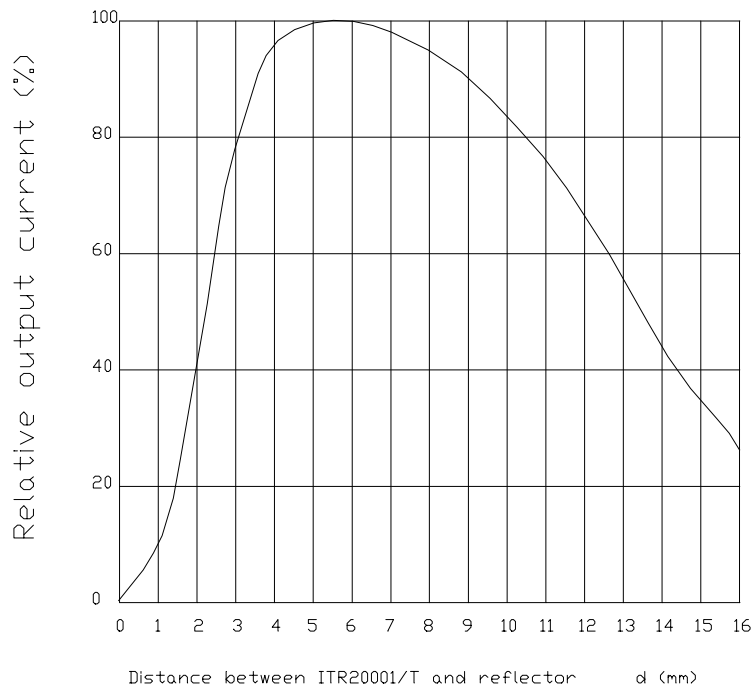



EVERLIGHT ELECTRONICS CO., LTD.

DEVICE NUMBER : CDRX-200-009 REV : 1
ECN : _____ PAGE : 7/8

Interrupter

MODEL NO : ITR20001/T24

■ Reliability Test Item And Condition

The reliability of products shall be satisfied with items listed below.

Confidence level:90%

LTPD:10%

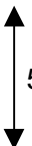
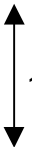
NO.	Item	Test Conditions	Test Hours/ Cycle	Sample Size	Failure Judgement Criteria	Ac/Re
1	Solder Heat	TEMP : 260°C ± 5 °C	5 secs	22 pcs	$I_{c(on)} \leq L \times 0.8$ L :Lower specification limit	0/1
2	Temperature Cycle	H : +85°C 30 mins  L : -55°C 30 mins	50 cycles	22 pcs		0/1
3	Thermal Shock	H : +100°C 5 mins  L : -10°C 30 mins	50 cycles	22 pcs		0/1
4	High Temperature Storage	TEMP. : +100°C	1000 hrs	22 pcs		0/1
5	Low Temperature Storage	TEMP. : -55°C	1000 hrs	22 pcs		0/1
6	DC Operating Life	$V_{CE}=5V$ $I_F=20mA$	1000 hrs	22 pcs		0/1
7	High Temperature / High Humidity	85°C / 85% R.H.	1000 hrs	22 pcs		0/1



EVERLIGHT ELECTRONICS CO., LTD.

DEVICE NUMBER : CDRX-200-009 REV : 1
ECN : _____ PAGE : 8/8

Interrupter

MODEL NO : ITR20001/T24

■ Packing Specifications

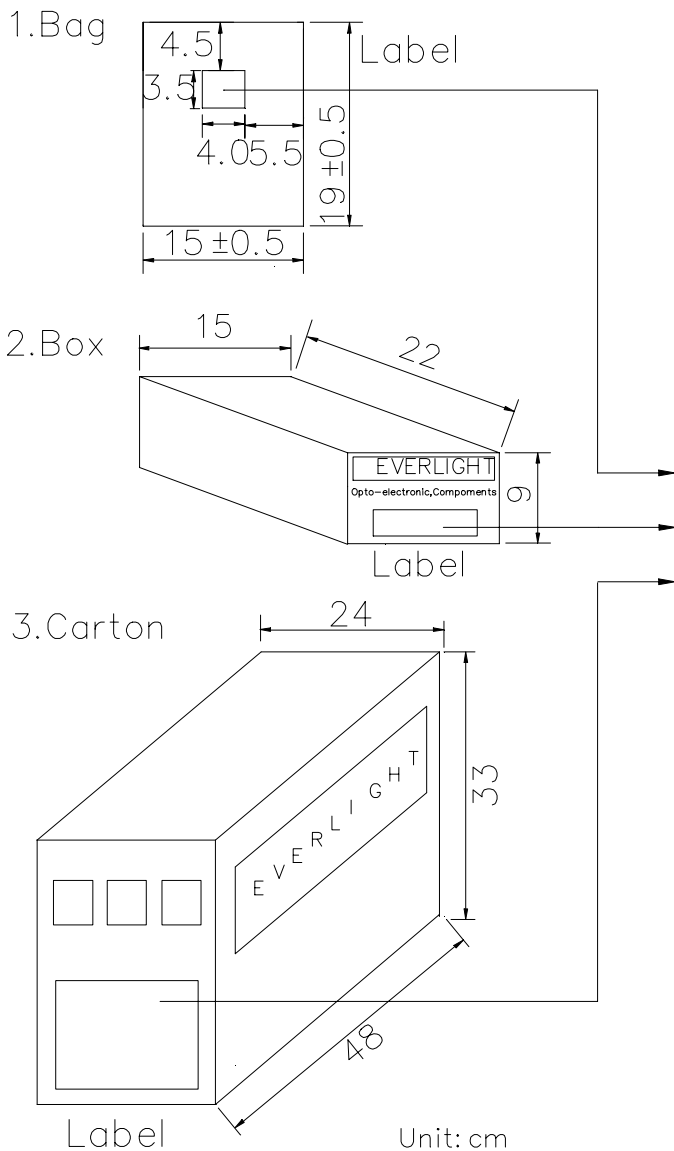

CPN:

P/N:



ITR20001/T24

QTY:



CAT:

HUE:

REF:

LOT NO:

CPN : Customer's Production Number

P/N : Production Number

QTY : Packing Quantity

CAT : Ranks

HUE : Peak Wavelength

REF : Reference

LOT NO : Lot Number

■ Packing Quantity Specification

1.150Pcs/1Bag

2.5Bags/1Box

3.10Boxes/1Carton