

BWHP Series



Due to accurate wire winding technology, these chip inductors are designed for filtering, impedance matching, resonance and choke circuits for RF designer. Both standard series custom designs are available.

Features

- RoHS Compliant and Halogen Free
- Ceramic body and wire wound construction provide high Q and SRFs
- Higher Q and lower DCR than other inductors
- Exceptional current handling capability
- HP series is for high power and high frequency application

Applications

- Wireless embedded portable devices
- GPS receiver
- Base Station
- Repeater
- Set Top Box
- Cable / IP Modem
- Security system and other RF modules

Product Identification

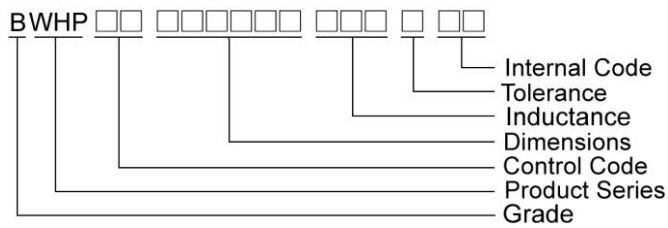

Shape and Dimensions / Recommended Pattern

BWHP00110706

BWHP00161008

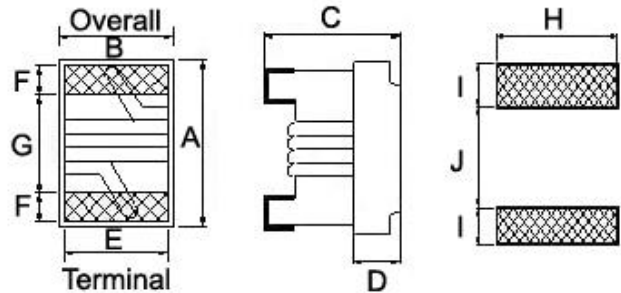
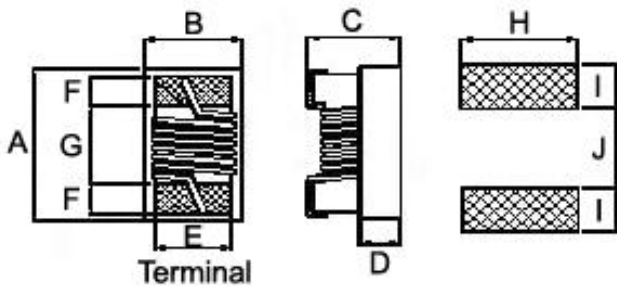

Dimensions

	A	B	C	D	E	F	G	H	I	J
BWHP00110706	1.1 ± 0.05	0.70 ± 0.05	0.6 ± 0.05	0.25	0.45	0.20	0.54	0.66	0.36	0.51
BWHP00161008	1.6 ^{+0.2} _{-0.1}	1.00 ± 0.1	0.82 ^{+0.2} _{-0.1}	0.30	0.70	0.30	0.95	1.02	0.64	0.64

Shape and Dimensions / Recommended Pattern

BWHP00231715

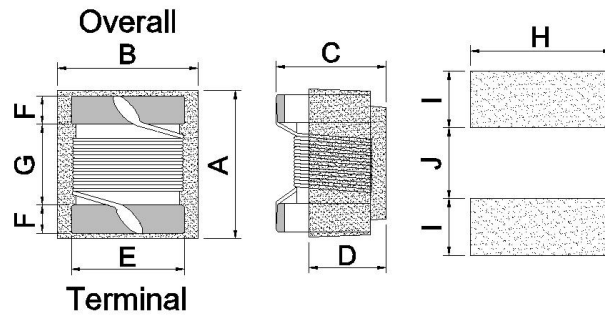

Dimensions

	A Max	B Max	C Max	D	E	F	G	H	I	J
BWHP00231715	2.35	1.73	1.52	0.71	1.27	0.30	1.44	1.78	1.02	0.76

SMD Wire Wound Ceramic Chip Inductors - BWHP Series

Electrical Characteristics

Part Number	Inductance (nH)	Tolerance (±%)	Test Frequency (MHz)	Q Typ.	Test Frequency (MHz)	SRF (GHz) Typ.	RDC (Ω) Max	Irms (mA) Max
BWHP001107061N0□00	1.0	±0.1nH	250	18	250	16.0	0.030	2300
BWHP001107062N0□00	2.0	±0.2nH	250	18	250	15.2	0.038	2100
BWHP001107062N2□00	2.2	±0.2nH	250	25	250	15.1	0.045	2100
BWHP001107062N4□00	2.4	±0.2nH	250	25	250	14.0	0.045	2000
BWHP001107062N7□00	2.7	±0.2nH	250	20	250	13.0	0.090	1500
BWHP001107063N3□00	3.3	3 / 5	250	20	250	12.8	0.050	1700
BWHP001107063N6□00	3.6	3 / 5	250	28	250	11.7	0.065	1700
BWHP001107063N9□00	3.9	3 / 5	250	28	250	9.50	0.065	1700
BWHP001107064N3□00	4.3	3 / 5	250	22	250	7.15	0.060	1600
BWHP001107064N7□00	4.7	3 / 5	250	18	250	6.85	0.115	1500
BWHP001107065N1□00	5.1	3 / 5	250	20	250	6.80	0.125	1200
BWHP001107065N6□00	5.6	3 / 5	250	28	250	6.80	0.070	1600
BWHP001107066N2□00	6.2	3 / 5	250	25	250	5.80	0.070	1600
BWHP001107066N8□00	6.8	3 / 5	250	25	250	5.80	0.095	1500
BWHP001107067N5□00	7.5	3 / 5	250	25	250	5.40	0.130	1400
BWHP001107068N2□00	8.2	3 / 5	250	30	250	5.40	0.080	1500
BWHP001107068N7□00	8.7	3 / 5	250	30	250	5.00	0.085	1500
BWHP001107069N0□00	9.0	3 / 5	250	28	250	5.00	0.090	1400
BWHP001107069N5□00	9.5	3 / 5	250	30	250	4.70	0.095	1400
BWHP0011070610N□00	10	3 / 5	250	30	250	4.70	0.120	1300
BWHP0011070611N□00	11	3 / 5	250	30	250	4.70	0.095	1400
BWHP0011070612N□00	12	3 / 5	250	25	250	4.40	0.110	1200
BWHP0011070613N□00	13	3 / 5	250	30	250	4.20	0.140	870
BWHP0011070615N□00	15	3 / 5	250	30	250	3.90	0.130	1100
BWHP0011070616N□00	16	3 / 5	250	30	250	3.70	0.150	850
BWHP0011070618N□00	18	3 / 5	250	30	250	3.55	0.160	900
BWHP0011070619N□00	19	3 / 5	250	30	250	3.50	0.175	850
BWHP0011070620N□00	20	3 / 5	250	30	250	3.50	0.220	780
BWHP0011070621N□00	21	3 / 5	250	30	250	1.70	0.360	450
BWHP0011070622N□00	22	3 / 5	250	30	250	3.30	0.210	800
BWHP0011070623N□00	23	3 / 5	250	30	250	3.15	0.210	700
BWHP0011070624N□00	24	3 / 5	250	30	250	3.15	0.260	700
BWHP0011070625N□00	25	3 / 5	250	30	250	3.15	0.310	700
BWHP0011070626N□00	26	3 / 5	250	30	250	3.15	0.275	700
BWHP0011070627N□00	27	3 / 5	250	30	250	3.20	0.300	450
BWHP0011070630N□00	30	3 / 5	250	30	250	2.90	0.350	450
BWHP0011070633N□00	33	3 / 5	250	30	250	2.80	0.380	490
BWHP0011070636N□00	36	3 / 5	250	30	250	2.80	0.480	480
BWHP0011070637N□00	37	3 / 5	250	30	250	2.70	0.490	470
BWHP0011070639N□00	39	3 / 5	250	30	250	2.60	0.520	450
BWHP0011070640N□00	40	3 / 5	250	30	250	2.60	0.520	450
BWHP0011070643N□00	43	3 / 5	250	29	250	2.50	0.720	450
BWHP0011070647N□00	47	3 / 5	250	30	250	2.40	0.720	420
BWHP0011070651N□00	51	3 / 5	250	30	250	2.30	0.980	360

Note: When ordering, please specify tolerance code. Tolerance : B=±0.1nH , C=±0.2nH , H=±3% , J=±5%

- Operating temperature range - 40°C ~ 125°C(Including self - temperature rise)
- Irms for a 15°C temperature rise from 25°C ambient with current
- Measure Equipment :
 L & Q : Agilent E4991A+Agilent HP16197A
 SRF : Agilent HP8753D/Agilent HP8722ES
 RDC : Chroma 16502
 Irms : HP4284A+HP42841A/HP4285A+HP42841A

Please be sure to request approval specifications that provide further details of the products. Kindly note that the content of these specifications are subject to change or may be discontinued without prior notice. This product may not be designed/used in medical or high risk applications without Chilisin approval. Please contact our sales department before ordering.



SMD Wire Wound Ceramic Chip Inductors - BWHP Series

Electrical Characteristics

Part Number	Inductance (nH)	Tolerance (±%)	Test Frequency (MHz)	Q Typ.	Test Frequency (MHz)	SRF (GHz) Typ.	RDC (Ω) Max	Irms (mA) Max	Color
BWHP001610081N8□00	1.8	5	250	23	250	16.0	0.033	2100	Black
BWHP001610082N2□00	2.2	5	250	13	250	15.0	0.182	900	Brown
BWHP001610083N9□00	3.9	5	250	26	250	7.50	0.062	1600	Red
BWHP001610084N3□00	4.3	3 / 5	250	26	250	7.50	0.088	1300	Orange
BWHP001610084N7□00	4.7	3 / 5	250	25	250	7.90	0.130	1100	Yellow
BWHP001610086N8□00	6.8	3 / 5	250	40	250	5.80	0.065	1400	Green
BWHP001610087N2□00	7.2	3 / 5	250	32	250	5.40	0.100	1400	Blue
BWHP001610087N5□00	7.5	3 / 5	250	32	250	5.30	0.100	1300	Violet
BWHP0016100811N□00	11	3 / 5	250	41	250	4.10	0.086	1400	Gray
BWHP0016100815N□00	15	3 / 5	250	42	250	3.60	0.110	1200	White
BWHP0016100816N□00	16	3 / 5	250	40	250	3.50	0.125	1100	Black
BWHP0016100822N□00	22	3 / 5	250	40	250	3.15	0.195	850	Brown
BWHP0016100823N□00	23	3 / 5	250	40	250	3.00	0.150	850	Red
BWHP0016100824N□00	24	3 / 5	250	42	250	2.95	0.125	1100	Orange
BWHP0016100827N□00	27	3 / 5	250	42	250	2.80	0.200	780	Yellow
BWHP0016100830N□00	30	3 / 5	250	49	250	2.80	0.130	920	Green
BWHP0016100833N□00	33	3 / 5	250	45	250	2.70	0.170	680	Blue
BWHP0016100836N□00	36	3 / 5	250	44	250	2.50	0.225	720	Violet
BWHP0016100839N□00	39	3 / 5	250	48	250	2.45	0.190	680	Gray
BWHP0016100843N□00	43	3 / 5	250	45	250	2.45	0.225	810	White
BWHP0016100847N□00	47	3 / 5	200	43	250	2.30	0.240	680	Black
BWHP0016100851N□00	51	3 / 5	200	42	250	2.30	0.280	660	Brown
BWHP0016100856N□00	56	3 / 5	200	43	250	2.20	0.300	610	Red
BWHP0016100868N□00	68	3 / 5	200	43	250	2.00	0.330	600	Orange
BWHP0016100872N□00	72	3 / 5	150	37	250	1.90	0.420	550	Yellow
BWHP0016100875N□00	75	3 / 5	150	37	250	1.90	0.520	500	Green
BWHP0016100882N□00	82	3 / 5	150	38	250	1.80	0.460	510	Blue
BWHP0016100891N□00	91	3 / 5	150	45	250	1.65	0.580	440	Violet
BWHP00161008R10□00	100	3 / 5	150	49	250	1.70	0.540	470	Gray
BWHP00161008R11□00	110	3 / 5	150	47	250	1.60	0.620	440	White
BWHP00161008R12□00	120	3 / 5	150	47	250	1.55	0.720	420	Black
BWHP00161008R15□00	150	3 / 5	150	47	250	1.35	1.150	390	Brown
BWHP00161008R18□00	180	3 / 5	100	48	250	1.30	1.500	310	Red
BWHP00161008R20□00	200	3 / 5	100	47	250	1.25	2.000	280	Orange
BWHP00161008R21□00	210	3 / 5	100	48	250	1.20	2.000	280	Yellow
BWHP00161008R22□00	220	3 / 5	100	47	250	1.10	2.000	280	Green
BWHP00161008R25□00	250	3 / 5	100	45	250	1.05	3.000	240	Blue
BWHP00161008R27□00	270	3 / 5	100	46	250	1.05	2.250	260	Violet
BWHP00161008R30□00	300	3 / 5	100	47	250	0.99	2.800	220	Gray
BWHP00161008R33□00	330	3 / 5	100	46	250	0.93	3.600	180	White
BWHP00161008R36□00	360	3 / 5	100	47	250	0.93	4.000	170	Black
BWHP00161008R39□00	390	3 / 5	100	47	250	0.88	4.000	170	Brown

Note: When ordering, please specify tolerance code. Tolerance : H=±3% , J=±5%

- Operating temperature range - 40°C ~ 125°C(Including self - temperature rise)
- Irms for a 15°C temperature rise from 25°C ambient with current
- Measure Equipment :
 L & Q : Agilent E4991A+Agilent HP16197A
 SRF : Agilent HP8753D/Agilent HP8722ES
 RDC : Chroma 16502
 Irms : HP4284A+HP42841A/HP4285A+HP42841A

SMD Wire Wound Ceramic Chip Inductors – BWHP Series

Test Instruments : Agilent E4991A Material/Impedance Analyzer

BWHP00110706

Typical **L** vs. **F** Frequency

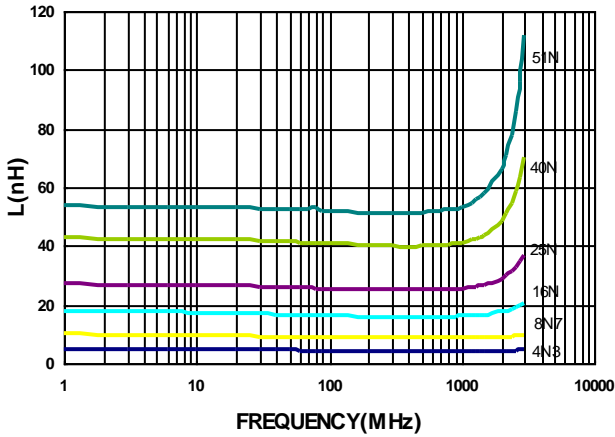

Typical **Q** vs. **F** Frequency

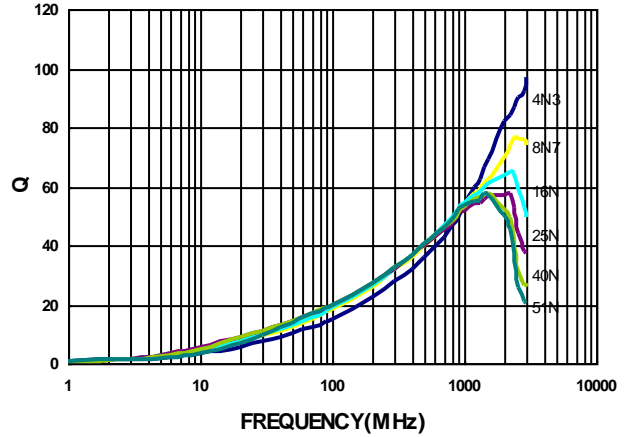

BWHP00161008

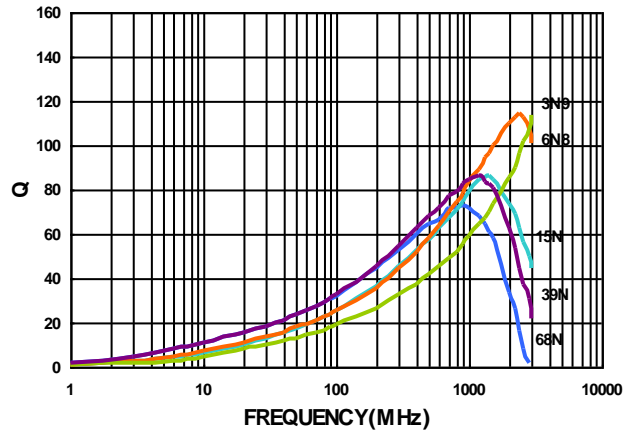
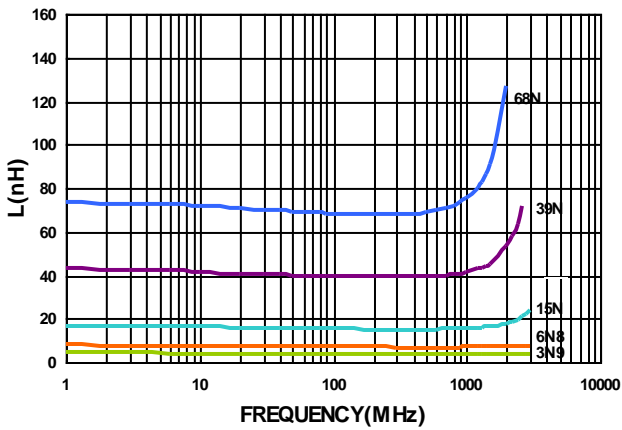

SMD Wire Wound Ceramic Chip Inductors - BWHP Series

Electrical Characteristics

Part Number	Inductance (nH)	Tolerance (±%)	Test Frequency (MHz)	Q Typ.	Test Frequency (MHz)	SRF (MHz) Typ.	RDC (Ω) Max	Irms (mA) Typ
BWHP002317152N6□00	2.6	5	250	100	1500	9500	0.015	2000
BWHP002317156N2□00	6.2	5	250	104	1000	7200	0.027	1500
BWHP002317156N8□00	6.8	5	250	90	1000	6000	0.066	1300
BWHP0023171511N□00	11	2 / 5	250	93	500	4750	0.039	1600
BWHP0023171512N□00	12	2 / 5	250	91	500	4425	0.039	1400
BWHP0023171513N□00	13	2 / 5	250	91	500	4100	0.039	1400
BWHP0023171518N□00	18	2 / 5	250	95	500	3650	0.050	1200
BWHP0023171533N□00	33	2 / 5	250	100	500	2410	0.087	1100
BWHP0023171547N□00	47	2 / 5	200	105	500	2170	0.093	1000
BWHP0023171556N□00	56	2 / 5	200	100	500	1815	0.122	950
BWHP0023171582N□00	82	2 / 5	150	103	500	1525	0.168	820
BWHP00231715R10□00	100	2 / 5	150	100	500	1400	0.220	720
BWHP00231715R12□00	120	2 / 5	150	80	250	1265	0.293	620
BWHP00231715R15□00	150	2 / 5	100	80	250	1150	0.288	600
BWHP00231715R18□00	180	2 / 5	100	77	250	1025	0.374	540
BWHP00231715R22□00	220	2 / 5	100	75	250	930	0.426	500
BWHP00231715R27□00	270	2 / 5	100	75	250	830	0.754	420
BWHP00231715R33□00	330	2 / 5	100	54	100	770	1.004	360
BWHP00231715R39□00	390	2 / 5	100	52	100	700	1.110	330
BWHP00231715R47□00	470	2 / 5	50	52	100	640	1.559	280
BWHP00231715R56□00	560	2 / 5	25	46	100	550	2.067	240
BWHP00231715R68□00	680	2 / 5	25	46	100	535	2.355	210
BWHP00231715R82□00	820	2 / 5	25	50	100	485	3.945	180

Note: When ordering, please specify tolerance code. Tolerance : G=±2% , J=±5%

- Operating temperature range - 40°C ~ 125°C(Including self - temperature rise)
- I rms for a 15°C temperature rise from 25°C ambient with current
- Measure Equipment :
 L & Q : Agilent E4991A+Agilent HP16197A
 SRF : Agilent HP8753D/Agilent HP8722ES
 RDC : Chroma 16502
 I rms : HP4284A+HP42841A/HP4285A+HP42841A

Typical **L** vs. **F** Frequency

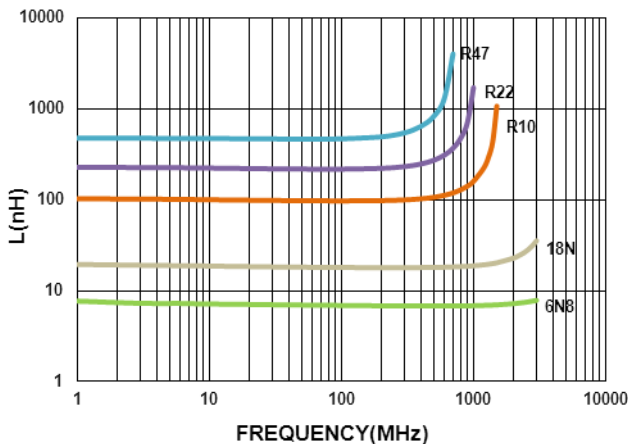

Typical **Q** vs. **F** Frequency

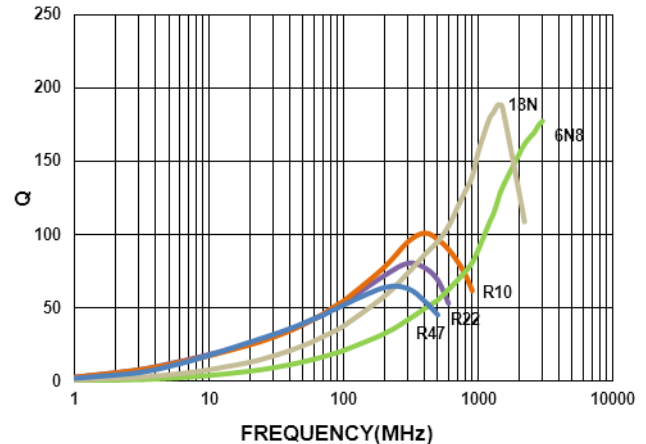

SMD Wire Wound Ceramic Chip Inductors - BWHP Series

Packaging Specifications

Tape Dimensions

Figure 1

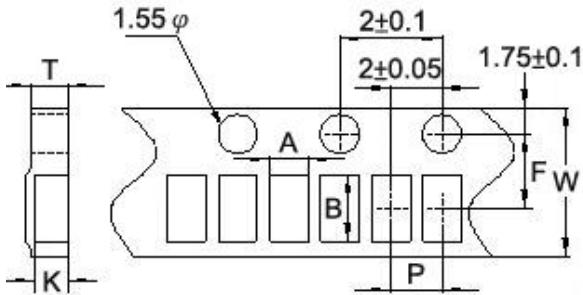

Tape Material

Carrier Tape: Paper
Cover Tape: Polystyrene

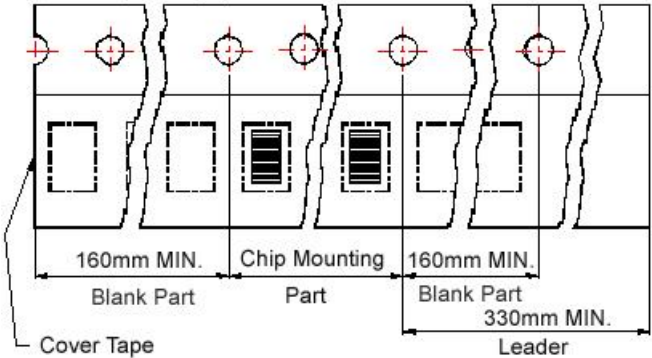
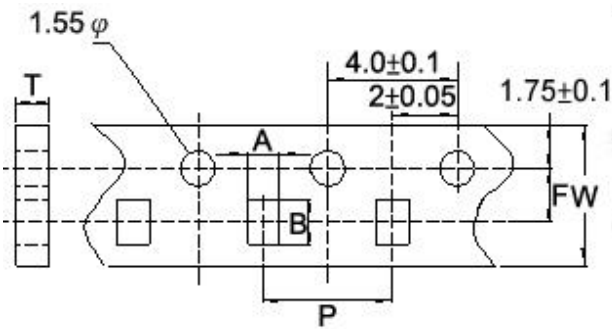

Figure 2



Carrier Tape: Paper
Cover Tape: Polystyrene

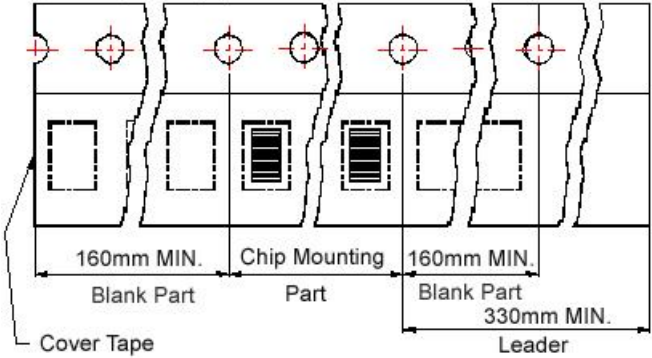
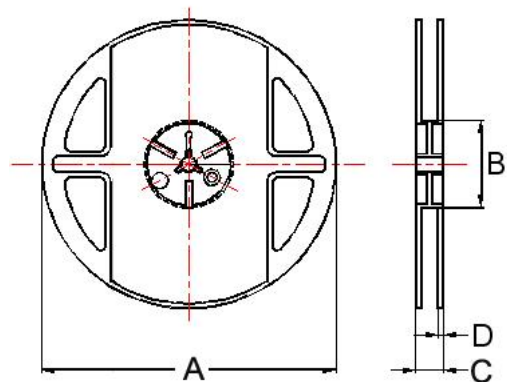
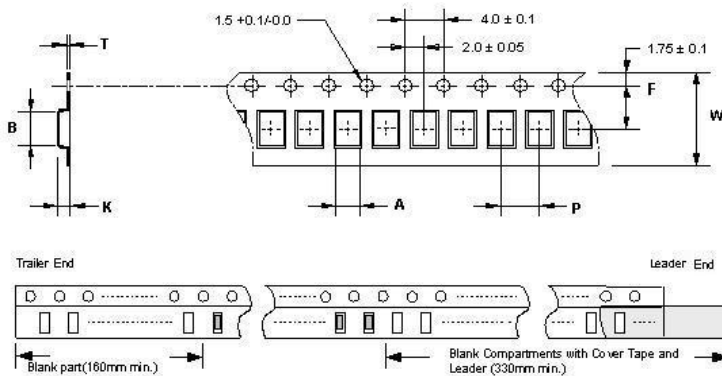

Figure 3

Reel Dimensions



Dimensions in mm

TYPE	Fig.	Tape Dimensions							Reel Dimensions				Quantity PCS / Reel
		A	B	T	W	P	F	K	A	B	C	D	
BWHP00110706	1	0.80	1.20	0.75	8	2	3.5	0.62	178	60	12	1.5	4000
BWHP00161008	2	1.23	1.90	1.05	8	4	3.5	-	178	60	12	1.5	4000
BWHP00231715	3	1.85	2.45	0.23	8	4	3.5	1.50	178	60	12	1.5	2000