



SOT-323 Plastic-Encapsulate Diode

BAS19W/20W/21W SWITCHING DIODE

FEATURES

- Fast Switching Speed
- Surface Mount Package Ideally Suited for Automatic Insertion
- For General Purpose Switching Applications
- High Conductance

MARKING:

BAS19W:KA8	BAS20W:KT2	BAS21W:KT3
		

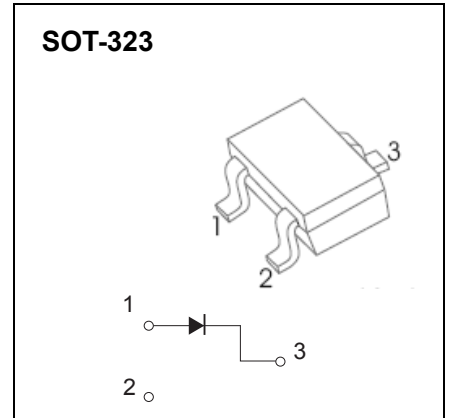

Solid dot = Green molding compound device, if none, the normal device.

Maximum Ratings @Ta=25°C

Parameter	Symbol	BAS19W	BAS20W	BAS21W	Unit
Peak Repetitive Reverse Voltage	V_{RRM}	100	150	250	V
DC Blocking Voltage	V_R				
Average Rectified Output Current	I_O	200			mA
Non-Repetitive Peak Forward Surge Current @t=8.3ms	I_{FSM}	2.5			A
Power Dissipation	P_D	200			mW
Thermal Resistance θ_{ca} Junction to Ambient	$R_{\theta JA}$	625			°C/W
Junction Temperature	T_J	150			°C
Storage Temperature Range	T_{STG}	-55~+150			°C

ELECTRICAL CHARACTERISTICS (Ta=25°C unless otherwise specified)

Parameter	Symbol	Test conditions	Min	Max	Unit
Reverse breakdown voltage	$V_{(BR)}$	$I_R=100\mu A$	100 150 250		V
Reverse voltage leakage current	I_R	$V_R=100V$ $V_R=150V$ $V_R=200V$		0.1	μA
Forward voltage	V_F	$I_F=100mA$ $I_F=200mA$		1 1.25	V
Diode capacitance	C_D	$V_R=0V, f=1MHz$		5	pF
Reverses recovery time	t_{rr}	$I_F=I_R=30mA, I_{rr}=0.1 \times I_R$		50	ns

Typical Characteristics

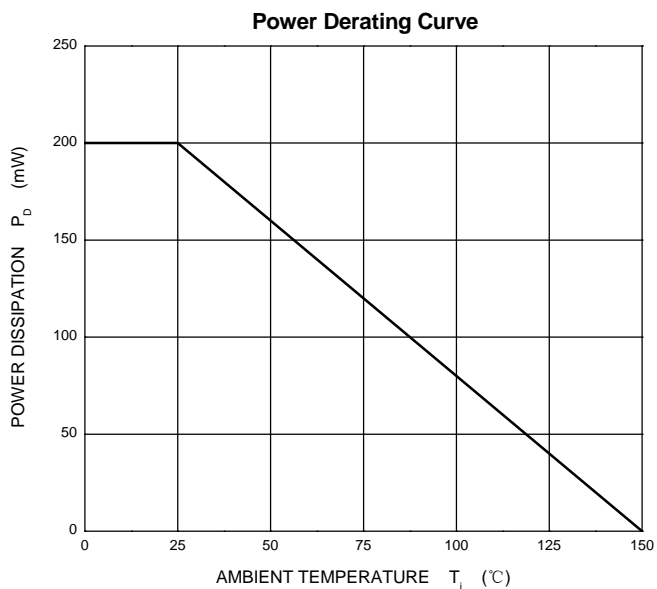
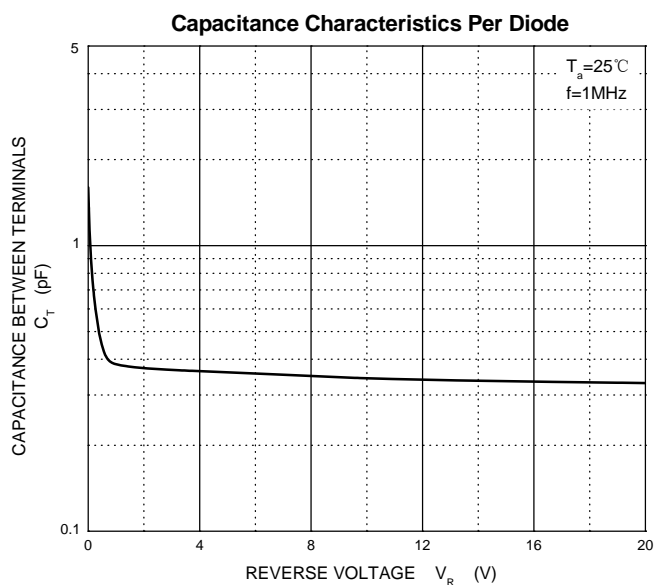
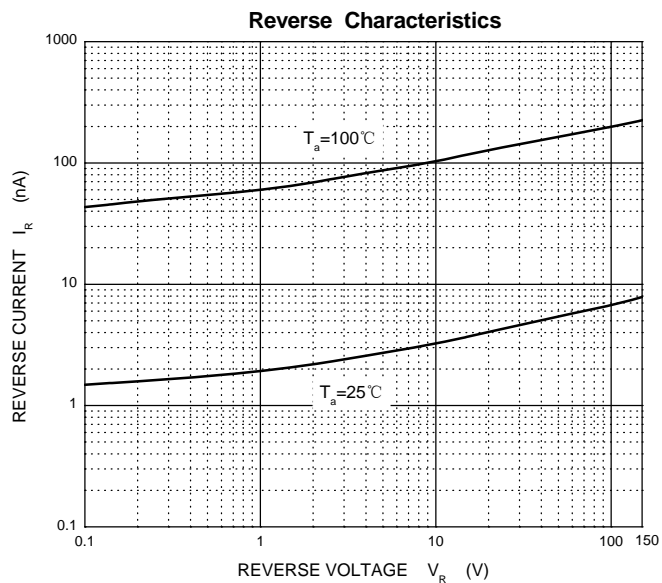
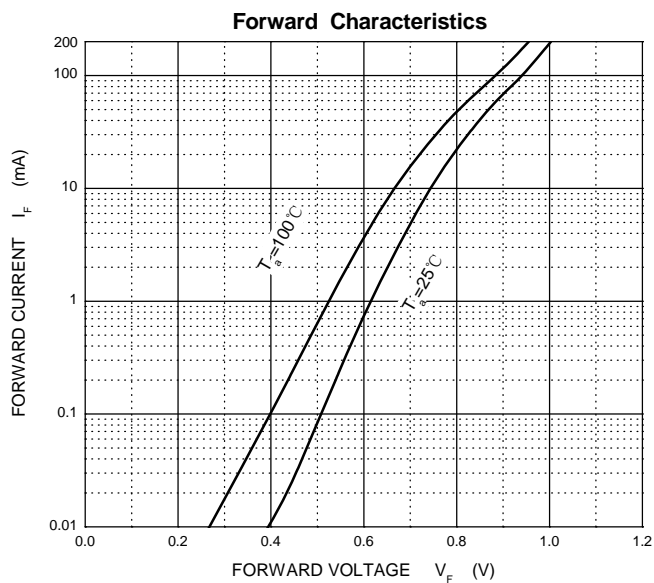

SOT-323 Package Outline Dimensions

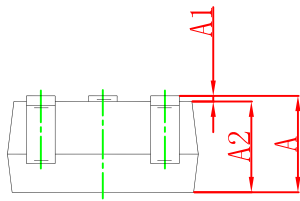
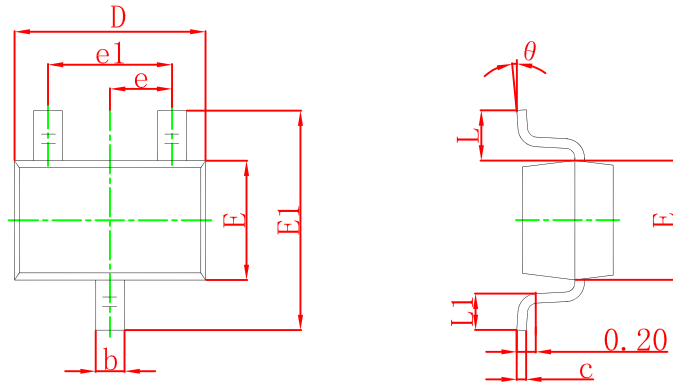

Symbol	Dimensions In Millimeters		Dimensions In Inches	
	Min	Max	Min	Max
A	0.900	1.100	0.035	0.043
A1	0.000	0.100	0.000	0.004
A2	0.900	1.000	0.035	0.039
b	0.200	0.400	0.008	0.016
c	0.080	0.150	0.003	0.006
D	2.000	2.200	0.079	0.087
E	1.150	1.350	0.045	0.053
E1	2.150	2.450	0.085	0.096
e	0.650 TYP		0.026 TYP	
e1	1.200	1.400	0.047	0.055
L	0.525 REF		0.021 REF	
L1	0.260	0.460	0.010	0.018
θ	0°	8°	0°	8°

SOT-323 Suggested Pad Layout

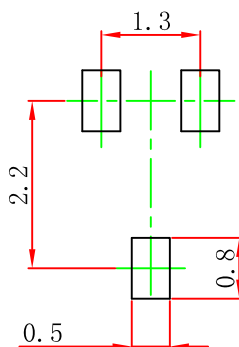

Note:

1. Controlling dimension: in millimeters.
2. General tolerance: ± 0.05 mm.
3. The pad layout is for reference purposes only.

NOTICE

JCET reserve the right to make modifications, enhancements, improvements, corrections or other changes without further notice to any product herein. JCET does not assume any liability arising out of the application or use of any product described herein.

SOT-323 Tape and Reel

SOT-323 Embossed Carrier Tape

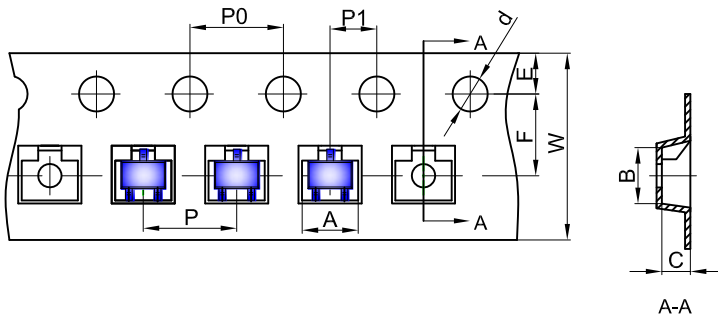

Packaging Description:

SOT-323 parts are shipped in tape. The carrier tape is made from a dissipative (carbon filled) polycarbonate resin. The cover tape is a multilayer film (Heat Activated Adhesive in nature) primarily composed of polyester film, adhesive layer, sealant, and anti-static sprayed agent. These reeled parts in standard option are shipped with 3,000 units per 7" or 17.8cm diameter reel. The reels are clear in color and is made of polystyrene plastic (anti-static coated).

Dimensions are in millimeter										
Pkg type	A	B	C	d	E	F	P0	P	P1	W
SOT-323	2.25	2.55	1.19	Ø1.55	1.75	3.50	4.00	4.00	2.00	8.00

SOT-323 Tape Leader and Trailer

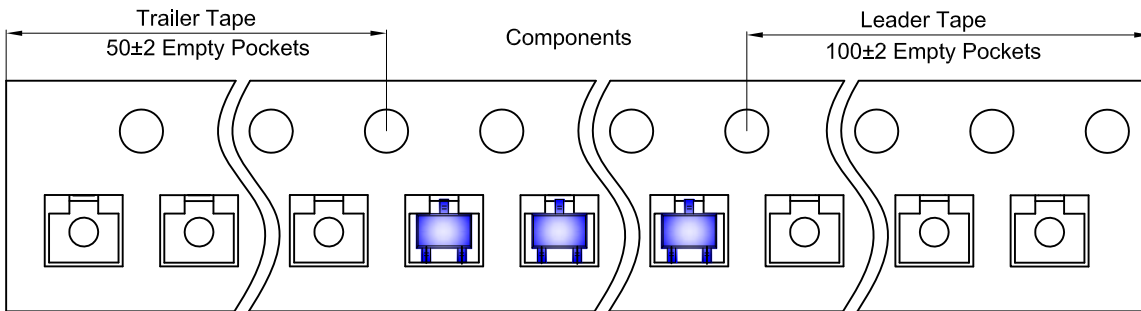

SOT-323 Reel

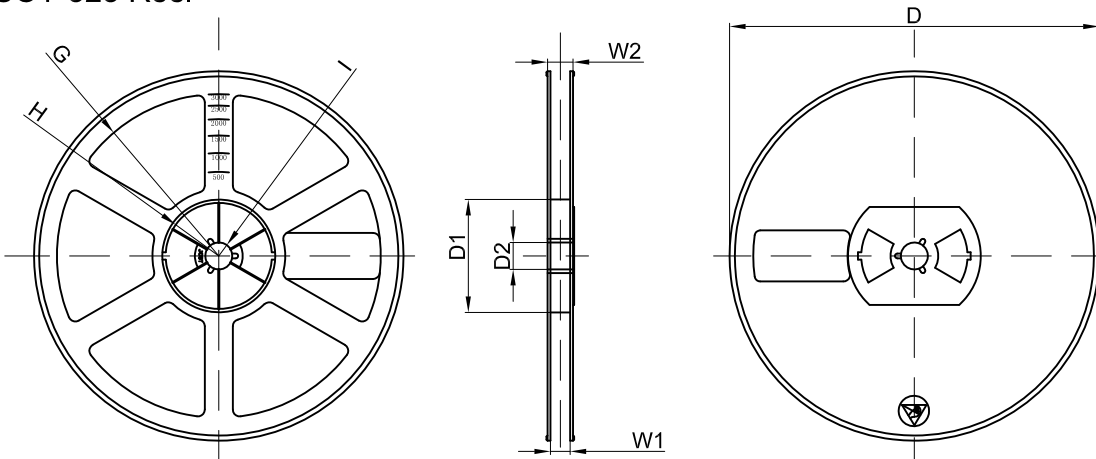

Dimensions are in millimeter								
Reel Option	D	D1	D2	G	H	I	W1	W2
7" Dia	Ø178.00	54.40	13.00	R78.00	R25.60	R6.50	9.50	12.30

REEL	Reel Size	Box	Box Size(mm)	Carton	Carton Size(mm)	G.W.(kg)
3000 pcs	7 inch	45,000 pcs	203×203×195	180,000 pcs	438×438×220	