

# MOC70T4

## OPTO INTERRUPTER



### Features

- Non-contact switching.
- For direct PC board or dual-in-line socket mounting.
- Fast switching speed.

### Application

- Scanner
- Edge,Position Detections
- FAX machine
- Counter

### Description

The MOC70T4 series consist of Gallium Arsenide infrared emitting diode and a NPN silicon phototransistor mounted in a black plastic housing. Phototransistor switching takes place whenever an opaque object passes through the slot. These series are designed for direct soldering into PC board or mounting in standard dual-in-line socket.

**PACKAGE DIMENSIONS**

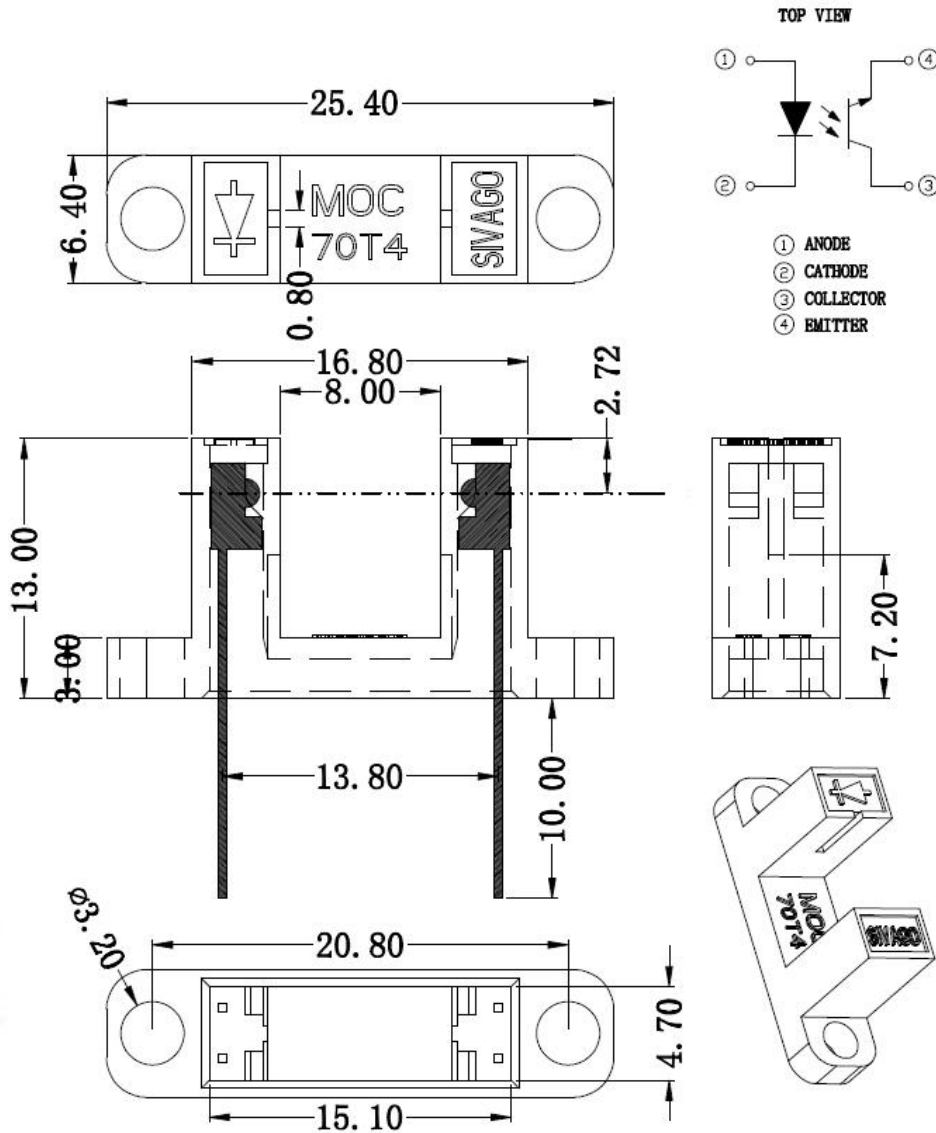

**NOTES:**

1. All dimensions are in millimeters (inches).
2. Tolerance is  $\pm 0.25\text{mm} (.010\text{'})$  unless otherwise noted.
3. Lead spacing is measured where the leads emerge from the package.

**ABSOLUTE MAXIMUM RATINGS AT TA=25°C**

PARAMETER	MAXIMUM RATING	UNIT
IR Diode Continuous Forward Current	50	mA
IR Diode Reverse Voltage	5	V
Transistor Collector Current	20	mA
Transistor Power Dissipation	100	mW
IR Diode Peak Power Current (Pulse Wide = 1μS, 300 pps)	3	A
Diode Power Dissipation	175	mW
Phototransistor Collector-Emitter Voltage	30	V
Phototransistor Emitter-Collector Voltage	5	V
Operating Temperature Range	-40°C to + 85°C	
Storage Temperature Range	-50°C to + 100°C	

**ELECTRICAL OPTICAL CHARACTERISTICS AT TA=25°C**

PARAMETER	SYMBOL	MIN.	TYP.	MAX.	UNIT	TEST CONDITION
<b>INPUT LED</b>						
Forward Voltage	V <sub>F</sub>		1.2	1.35	V	I <sub>F</sub> = 20mA
Reverse Current	I <sub>R</sub>			100	μA	V <sub>R</sub> =5V
<b>OUTPUT PHOTOTRANSISTOR</b>						
Collector-Emitter Breakdown Voltage	V(BR) <sub>CEO</sub>	30			V	I <sub>C</sub> =1mA
Emitter-Collector Breakdown Voltage	V(BR) <sub>CEO</sub>	5			V	I <sub>E</sub> =0.1mA
Collector-Emitter Dark Current	I <sub>CEO</sub>			100	nA	V <sub>CE</sub> =10V
<b>COUPLER</b>						
Collector-Emitter Saturation Voltage	V <sub>CE(SAT)</sub>			0.4	V	I <sub>C</sub> =0.2mA I <sub>F</sub> =20mA
Current Transfer Ratio	I <sub>c(on)</sub>	0.8			mA	V <sub>CE</sub> =5V I <sub>F</sub> =20mA

**TYPICAL ELECTRICAL / OPTICAL CHARACTERISTICS CURVES**

(25°C Ambient Temperature Unless Otherwise Noted)

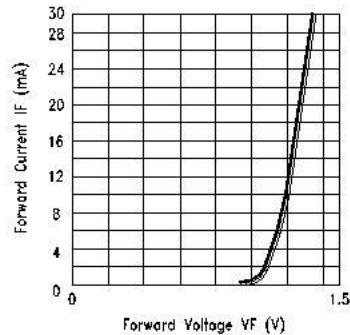

Fig.1 FORWARD CURRENT VS. FORWARD VOLTAGE

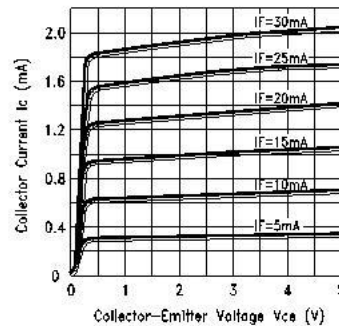

Fig.2 COLLECTOR CURRENT VS. COLLECTOR VOLTAGE

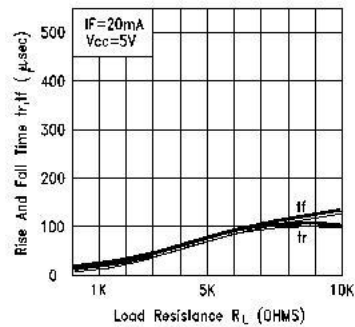

Fig.3 RISE AND FALL TIME VS. LOAD RESISTANCE

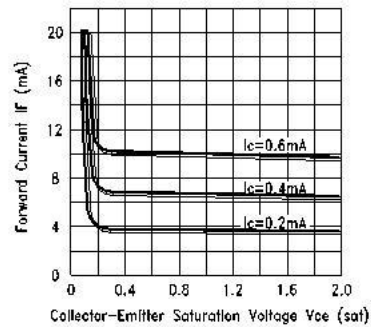

Fig.4 FORWARD CURRENT VS. COLLECTOR-EMITTER SATURATION VOLTAGE

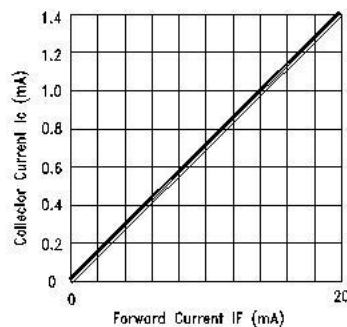



Fig.5 COLLECTOR CURRENT V.S FORWARD CURRENT

**Packing Quantity Specification**

1.200Pcs/1Bag,10 Bag/1Box

2.4Boxes/1Carton

**Label Form Specification**

製品名 PRODUCT	
コードNo. CODE No.	
数量 Q' TY	
ロットNo. LOT No.	
備考 REMARKS	
	

- PRODUCT: Part Number
- CODE NO.: Product Serial Number
- QTY: Packing Quantity
- LOT No: Lot Number
- REMARKS:Remarks

**Notes**

**Lead Forming**

1. During lead frame bending, the lead frame should be bent at a distance more than 3mm from bottom of the epoxy.

Note: Must fix lead frame and do not touch epoxy before bending to avoid Photo Interrupter broken.

2. Lead forming should be done before soldering.

3. Avoid stressing the Photo Interrupter package during leads forming. The stress to the base may damage the characteristics of Photo Interrupter, or it may break the Photo Interrupter.

4. Cut the Photo Interrupter lead frame at room temperature. Cutting the lead frame at high temperatures may cause failure of the Photo Interrupter.

5. When mounting the Photo Interrupter onto a PCB, the PCB holes must be aligned exactly with the lead position of the Photo Interrupter. If the Photo Interrupter are mounted with stress at The leads, it causes deterioration of the epoxy resin and this will degrade the Photo Interrupter.

**Soldering**

- Careful attention should be paid during soldering. When soldering, leave more than 3mm from solder joint to epoxy bulb, and soldering beyond the base of the tie bar is recommended.
- Recommended soldering conditions:

Hand Soldering		DIP Soldering	
Temp. at tip of iron	300°C Max. (30W Max.)	Preheat temp.	100°C Max. (60 sec Max.)
Soldering time	3 sec Max.	Bath temp. & time	260 Max., 5 sec Max
Distance	3mm Min.(From solder joint to epoxy bulb)	Distance	3mm Min. (From solder joint to epoxy bulb)

- Recommended soldering profile

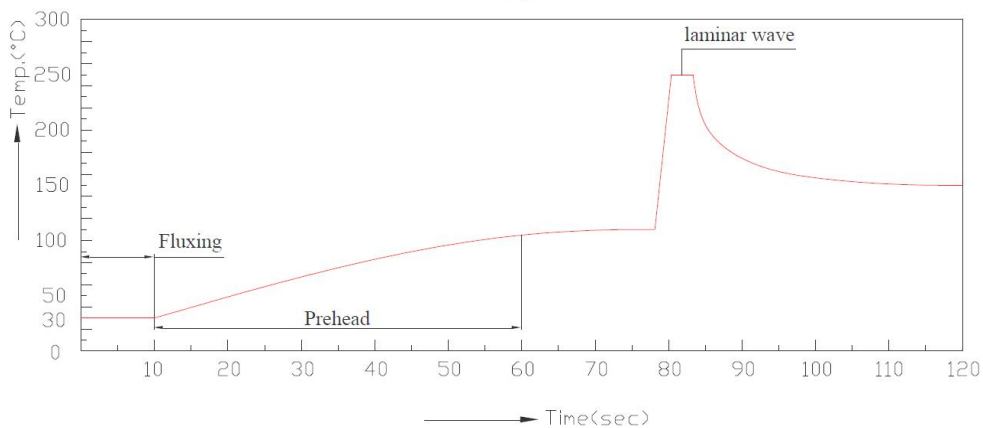

- Avoiding applying any stress to the lead frame while the Photo Interrupter are at high temperature particularly when soldering.
- Dip and hand soldering should not be done more than one time
- After soldering the Photo Interrupter, the epoxy bulb should be protected from mechanical shock or vibration until the Photo Interrupter return to room temperature.
- A rapid-rate process is not recommended for cooling the Photo Interrupter down from the peak temperature.
- Although the recommended soldering conditions are specified in the above table, dip or hand soldering at the lowest possible temperature is desirable for the Photo Interrupter.
- Wave soldering parameter must be set and maintain according to recommended temperature and dwell time in the solder wave.