

LA301A

OPTO INTERRUPTER



Features

- Non-contact switching.
- For direct PC board or dual-in-line socket mounting.
- Fast switching speed.

Application

- Scanner
- Edge,Position Detections
- FAX machine
- Counter

Description

The LA301A series consist of Gallium Arsenide infrared emitting diode and a NPN silicon phototransistor mounted in a black plastic housing. Phototransistor switching takes place whenever an opaque object passes through the slot. These series are designed for direct soldering into PC board or mounting in standard dual-in-line socket.

PACKAGE DIMENSIONS

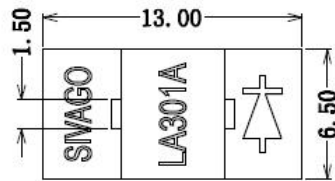

TOP VIEW

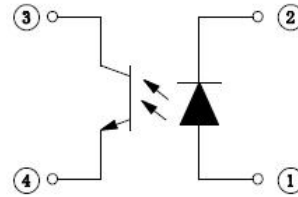

- ① ANODE
- ② CATHODE
- ③ COLLECTOR
- ④ EMITTER

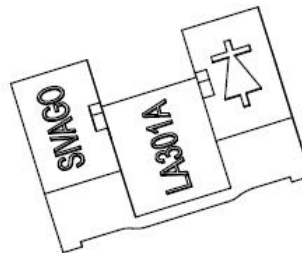
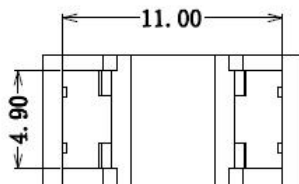
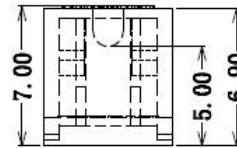
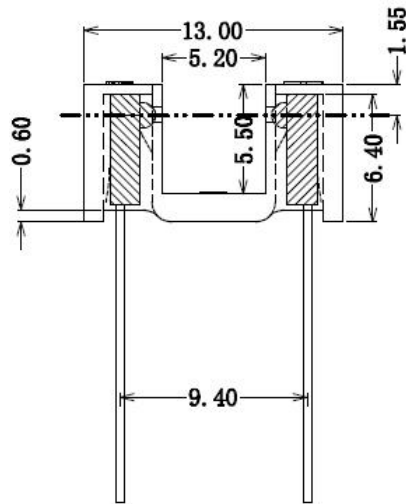

NOTES:

1. All dimensions are in millimeters (inches).
2. Tolerance is $\pm 0.25\text{mm} (.010\text{'})$ unless otherwise noted.
3. Lead spacing is measured where the leads emerge from the package.

ABSOLUTE MAXIMUM RATINGS AT TA=25°C

| PARAMETER | MAXIMUM RATING | UNIT |
|--|------------------|------|
| IR Diode Continuous Forward Current | 50 | mA |
| IR Diode Reverse Voltage | 5 | V |
| Transistor Collector Current | 20 | mA |
| Transistor Power Dissipation | 100 | mW |
| IR Diode Peak Power Current (Pulse Wide = 1μS, 300 pps) | 3 | A |
| Diode Power Dissipation | 175 | mW |
| Phototransistor Collector-Emitter Voltage | 30 | V |
| Phototransistor Emitter-Collector Voltage | 5 | V |
| Operating Temperature Range | -40°C to + 85°C | |
| Storage Temperature Range | -50°C to + 100°C | |

ELECTRICAL OPTICAL CHARACTERISTICS AT TA=25°C

| PARAMETER | SYMBOL | MIN. | TYP. | MAX. | UNIT | TEST CONDITION |
|---|----------------------|------|------|------|------|---|
| INPUT LED | | | | | | |
| Forward Voltage | V _F | | 1.2 | 1.35 | V | I _F = 20mA |
| Reverse Current | I _R | | | 100 | μA | V _R =5V |
| OUTPUT PHOTOTRANSISTOR | | | | | | |
| Collector-Emitter Breakdown Voltage | V(BR) _{CEO} | 30 | | | V | I _C =1mA |
| Emitter-Collector Breakdown Voltage | V(BR) _{CEO} | 5 | | | V | I _E =0.1mA |
| Collector-Emitter Dark Current | I _{CEO} | | | 100 | nA | V _{CE} =10V |
| COUPLER | | | | | | |
| Collector-Emitter Saturation Voltage | V _{CE(SAT)} | | | 0.4 | V | I _C =0.2mA I _F =20mA |
| Current Transfer Ratio | I _{c(on)} | 0.8 | | | mA | V _{CE} =5V I _F =20mA |

TYPICAL ELECTRICAL / OPTICAL CHARACTERISTICS CURVES

(25°C Ambient Temperature Unless Otherwise Noted)

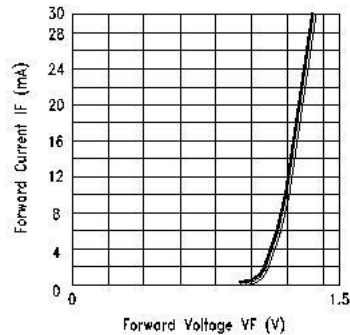

Fig.1 FORWARD CURRENT VS. FORWARD VOLTAGE

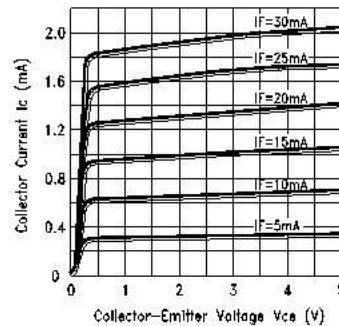

Fig.2 COLLECTOR CURRENT VS. COLLECTOR VOLTAGE

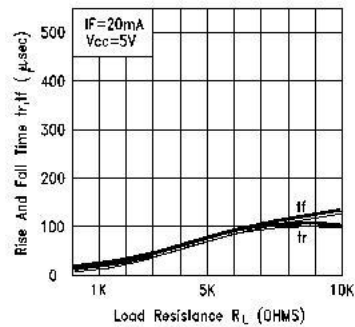

Fig.3 RISE AND FALL TIME VS. LOAD RESISTANCE

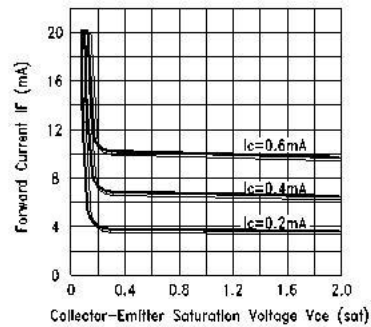

Fig.4 FORWARD CURRENT VS. Collector-Emitter Saturation Voltage

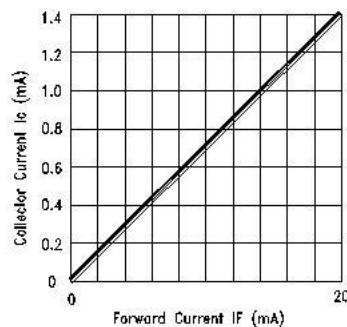

Fig.5 COLLECTOR CURRENT V.S FORWARD CURRENT

Packing Quantity Specification

1.200Pcs/1Bag,10 Bag/1Box

2.4Boxes/1Carton

Label Form Specification

| | |
|--|--|
| 製品名 PRODUCT | |
| コードNo. CODE No. | |
| 数量 Q' TY | |
| ロットNo. LOT No. | |
| 備考 REMARKS | |
|  | |

- PRODUCT: Part Number
- CODE NO.: Product Serial Number
- QTY: Packing Quantity
- LOT No: Lot Number
- REMARKS:Remarks

Notes

Lead Forming

1. During lead frame bending, the lead frame should be bent at a distance more than 3mm from bottom of the epoxy.
Note: Must fix lead frame and do not touch epoxy before bending to avoid Photo Interrupter broken.
2. Lead forming should be done before soldering.
3. Avoid stressing the Photo Interrupter package during leads forming. The stress to the base may damage the characteristics of Photo Interrupter, or it may break the Photo Interrupter.
4. Cut the Photo Interrupter lead frame at room temperature. Cutting the lead frame at high temperatures may cause failure of the Photo Interrupter.
5. When mounting the Photo Interrupter onto a PCB, the PCB holes must be aligned exactly with the lead position of the Photo Interrupter. If the Photo Interrupter are mounted with stress at The leads, it causes deterioration of the epoxy resin and this will degrade the Photo Interrupter.

Soldering

- Careful attention should be paid during soldering. When soldering, leave more than 3mm from solder joint to epoxy bulb, and soldering beyond the base of the tie bar is recommended.
- Recommended soldering conditions:

| Hand Soldering | | DIP Soldering | |
|----------------------|---|-------------------|--|
| Temp. at tip of iron | 300°C Max. (30W Max.) | Preheat temp. | 100°C Max. (60 sec Max.) |
| Soldering time | 3 sec Max. | Bath temp. & time | 260 Max., 5 sec Max |
| Distance | 3mm Min.(From solder joint to epoxy bulb) | Distance | 3mm Min. (From solder joint to epoxy bulb) |

- Recommended soldering profile

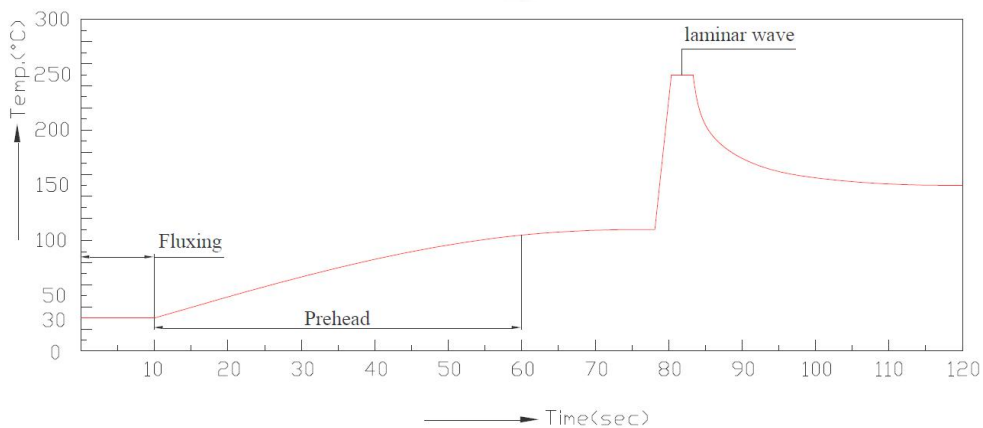

- Avoiding applying any stress to the lead frame while the Photo Interrupter are at high temperature particularly when soldering.
- Dip and hand soldering should not be done more than one time
- After soldering the Photo Interrupter, the epoxy bulb should be protected from mechanical shock or vibration until the Photo Interrupter return to room temperature.
- A rapid-rate process is not recommended for cooling the Photo Interrupter down from the peak temperature.
- Although the recommended soldering conditions are specified in the above table, dip or hand soldering at the lowest possible temperature is desirable for the Photo Interrupter.
- Wave soldering parameter must be set and maintain according to recommended temperature and dwell time in the solder wave.