

ARKLED 无锡市方舟科技电子有限公司

WUXI ARK TECHNOLOGY ELECTRONIC CO., LTD

规格(承认)书

Specification for approval

※ 方舟 P/N (ARKLED P/N): SM410561N

※ 客户 P/N (CUSTOMER P/N): _____

※ 产品说明 (DESCRIPTION):

1、

2、

3、

※ 日期 (DATE): 2011 年 12 月 8 日

地址: 江苏省宜兴市张渚镇金张渚工业区宇龙路 6 号

ADD: NO.6 Yulong Road, ZHANGZHU TOWN, YIXING CITY, JIANGSU PROVINCE,
P.R.CHINA

电话 (TEL): 0086-510-87341161 87345700

传真(FAX): 0086-510-87342800

E-mail: zhuzp@arkch.com

网址(http): www.arkch.com

型号 Type :

SM410561N



■ 产品特征 FEATURES:

- 高可靠性和高稳定性

High intensity and reliability

- 高品质、和低功耗、低成本

High quality, Low power requirement and low cost

- IC 易兼容、易装配

IC compatible , Easy assembly

- 符合 RoHS 指令要求

Meet RoHS EU Directive

- 静电承受能力 2000V

ESD 2000V

■ 产品描述 DESCRIPTION:

- 0.56 英寸单位数码管

0.56 Inch Single Digits Display

- 极性共阳

Common Anode

- 黑面, 白胶

Black face, white segment

- 发光颜色

Lighting Color:

- 1、红色 RED

- 2、

- 3、

- 4、

- 5、

- 晶片材质

- 1、AlGaInP

- 2、

- 3、

- 4、

- 5、

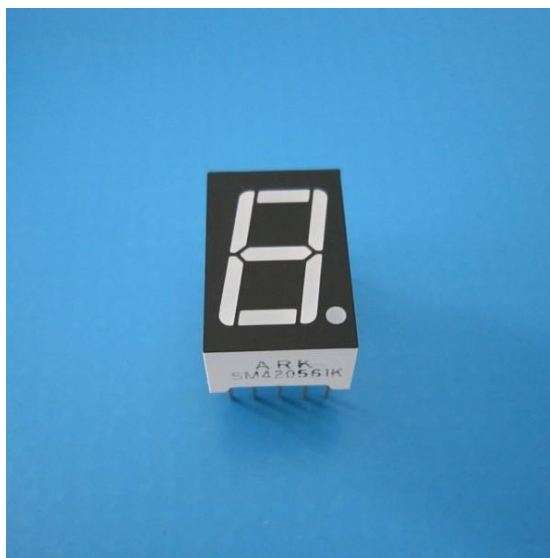

实物参考图

型号 Type :

SM410561N



■ 产品最大绝对参数值 (Ta: 25°C) ABSOLUTE MAXIMUM RATINGS AT Ta=25°C :

| PARAMETER 项目 | SYMBOL 符号 | RED 红色 | UNIT 单位 |
|--|--------------|---------------|------------|
| Power Dissipation Per Segment 功耗 | PAD | 50 | mw |
| Reverse Voltage Per Segment 反向耐压 | VR | 5 | V |
| Continuous Forward Current Per Segment 最大使用电流 | IAF | 20 | mA |
| Peak Forward Current Per Segment(Duty-0.1,1KHz) 最大峰值电流 | IPF | 60 | mA |
| Operating Temperature Range 工作温度 | TOPr | -20°C to 80°C | |
| Storage Temperature Range 贮藏温度 | Tstg | -30°C to 85°C | |
| Lead Soldering Temperature 260°C at 1.6mm From Body for 3 second 焊接温度 260°C/3 秒 距离胶体 1.6mm 以上 | | | |

■ 产品光电参数值 (Ta: 25°C) ELECTRICAL/OPTICAL CHARACTERISTICS AT Ta=25°C :

| PARAMETER 项目 | SYMBOL 符号 | TEST CONDITION 测试条件 | Color 颜色 | MIN 最小值 | TYP 标准值 | MAX 最大值 | UNIT 单位 |
|--|--------------|---------------------------|-------------|------------|------------|------------|------------|
| Forward Voltage ,Per Segment 正向压降 | VF | IF=20mA | 红色 RED | 1.9 | 2 | 2.5 | V |
| Reverse Current , Per Segment 反向漏电流 | IR | VR=5V | 红色 RED | | | 50 | μA |
| Peak Emission Wavelength 峰值波长 | λp | IF=20mA | 红色 RED | 630 | 633 | 637 | nm |
| Luminous Intensity Per Segment 法向光强 | IV | IF=20mA | 红色 RED | 23 | 25 | 28 | mcd |

型号 Type :
SM410561N



Fig 1. Forward Current vs. Forward Voltage

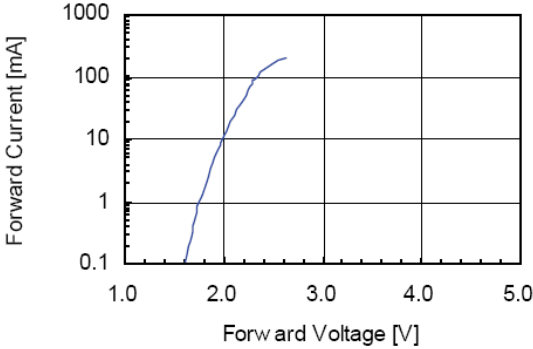

Fig 2. Relative Intensity vs. Forward Current

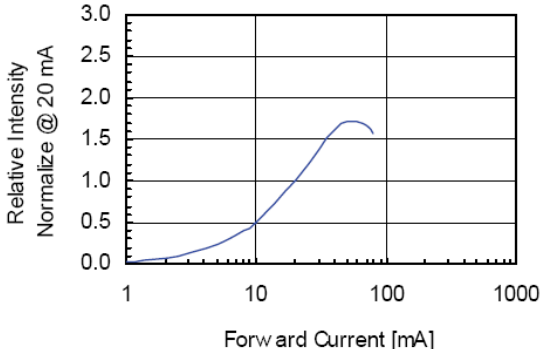

Fig 3. Forward Voltage vs. Temperature

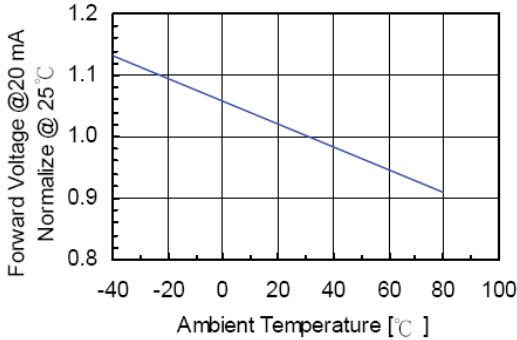

Fig 4. Relative Intensity vs. Temperature

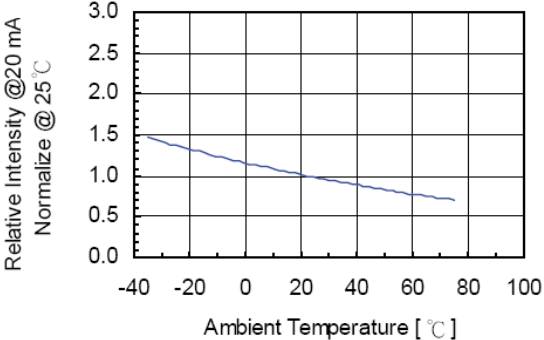
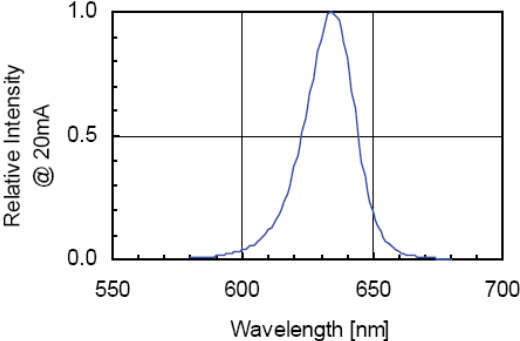
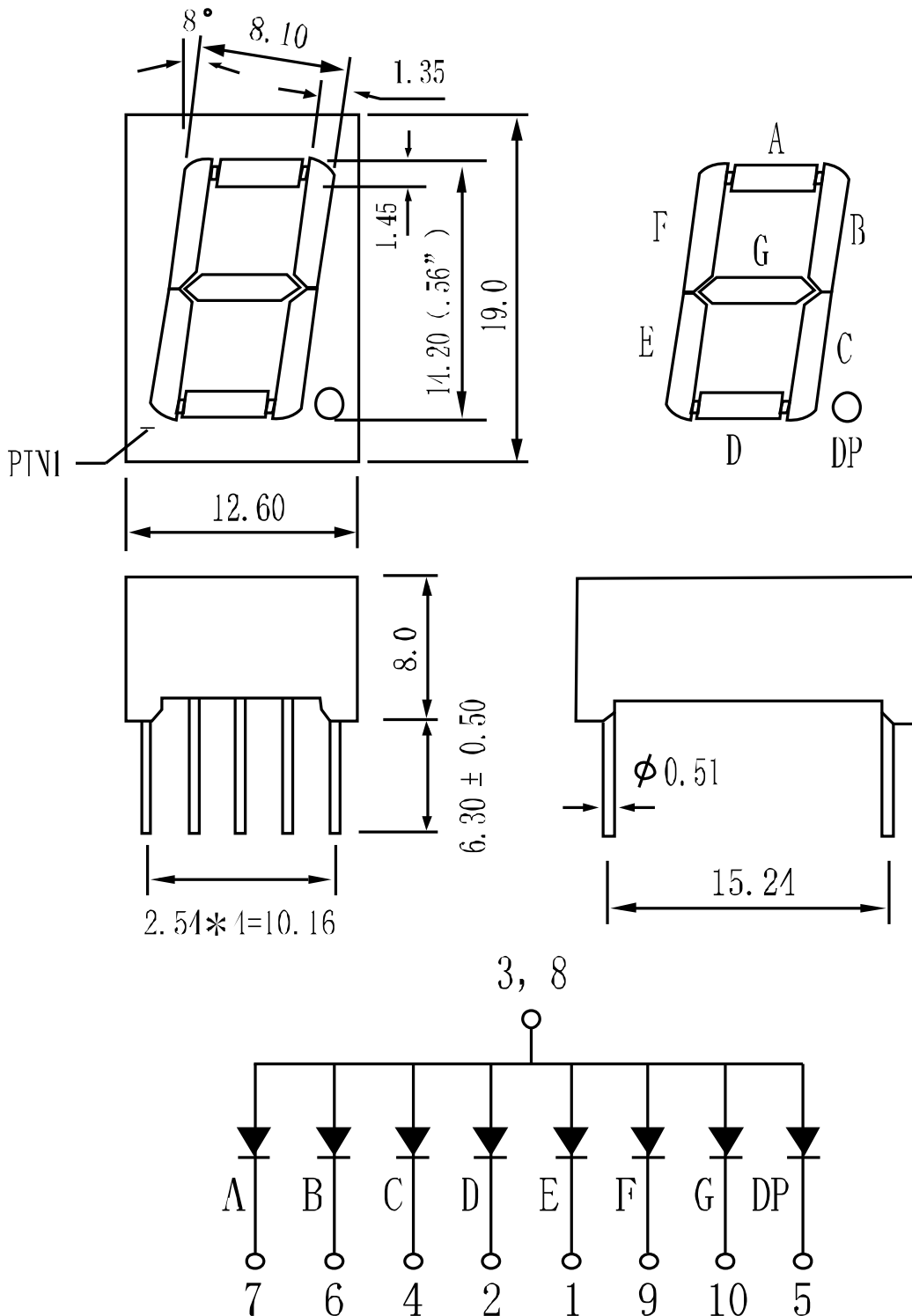

Fig 5. Relative Intensity vs. Wavelength



型号 Type :

SM410561N



NOTES : 1. All dimensions are in millimeters. (inches)

2. Tolerance is $\pm 0.25(0.010")$ unless otherwise specified.