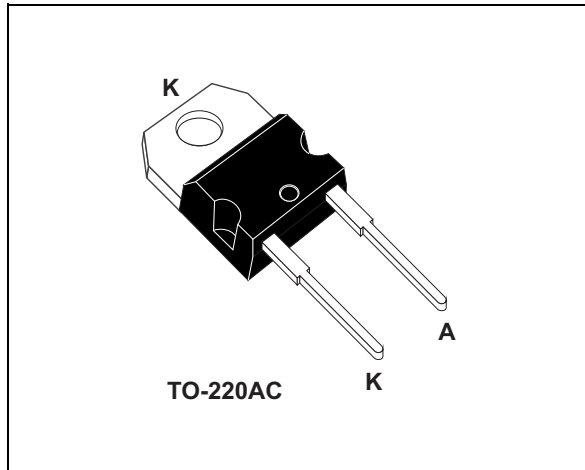

**Turbo 2 ultrafast high voltage rectifier**

Datasheet – production data

**Description**

The STTH8S12 is developed using ST's Turbo 2 1200 V technology. It is well-suited as a boost diode, especially for use in UPS.

**Table 1. Device summary**

Symbol	Value
$I_{F(AV)}$	8 A
$V_{RRM}$	1200 V
$t_{rr}$ (typ)	32 ns
$V_F$ (typ)	1.75 V
$T_j$ (max)	175 °C

**Features**

- Ultrafast switching
- Low reverse current
- Low thermal resistance
- Reduces switching and conduction losses

# 1 Characteristics

**Table 2. Absolute ratings (limiting values at  $T_j = 25\text{ °C}$ , unless otherwise specified)**

Symbol	Parameter		Value	Unit
$V_{RRM}$	Repetitive peak reverse voltage		1200	V
$I_{F(RMS)}$	Forward rms current		25	A
$I_{F(AV)}$	Average forward current, $\delta = 0.5$	$T_c = 110\text{ °C}$	8	A
$I_{FSM}$	Surge non repetitive forward current	$t_p = 10\text{ ms sinusoidal}$	70	A
$T_{stg}$	Storage temperature range		-65 to +175	°C
$T_j$	Maximum operating junction temperature		175	°C

**Table 3. Thermal parameters**

Symbol	Parameter	Value	Unit
$R_{th(j-c)}$	Junction to case	2.3	°C/W

**Table 4. Static electrical characteristics**

Symbol	Parameter	Test conditions	Min.	Typ.	Max.	Unit
$I_R^{(1)}$	Reverse leakage current	$T_j = 25\text{ °C}$			5	$\mu\text{A}$
		$T_j = 150\text{ °C}$			20	
$V_F^{(2)}$	Forward voltage drop	$T_j = 25\text{ °C}$	$I_F = 8\text{ A}$		2.7	V
		$T_j = 150\text{ °C}$			1.75	

1. Pulse test:  $t_p = 5\text{ ms}$ ,  $\delta < 2\%$
2. Pulse test:  $t_p = 380\text{ }\mu\text{s}$ ,  $\delta < 2\%$

To evaluate the conduction losses use the following equation:

$$P = 1.7 \times I_{F(AV)} + 0.1 I_{F(RMS)}^2$$

**Table 5. Dynamic characteristics**

Symbol	Parameter	Test conditions	Min.	Typ.	Max.	Unit
$t_{rr}$	Reverse recovery time	$T_j = 25\text{ °C}$		32	45	ns
$I_{RM}$	Reverse recovery current	$T_j = 125\text{ °C}$			11	15
S	Softness factor				2	
$Q_{RR}$	Reverse recovery charge				800	

Figure 1. Average forward power dissipation versus average forward current

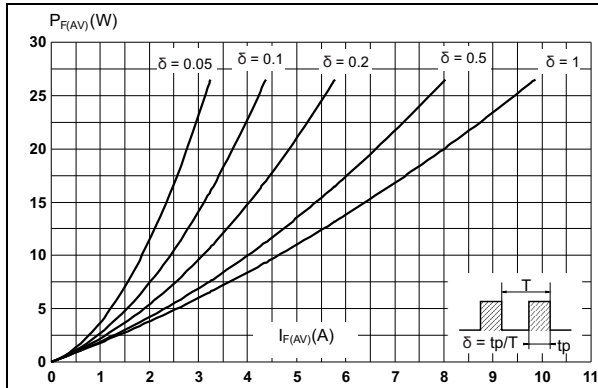

Figure 2. Forward voltage drop versus forward current (typical values)

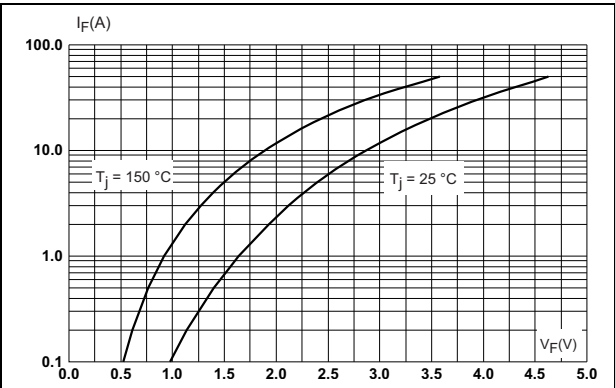

Figure 3. Forward voltage drop versus forward current (maximum values)

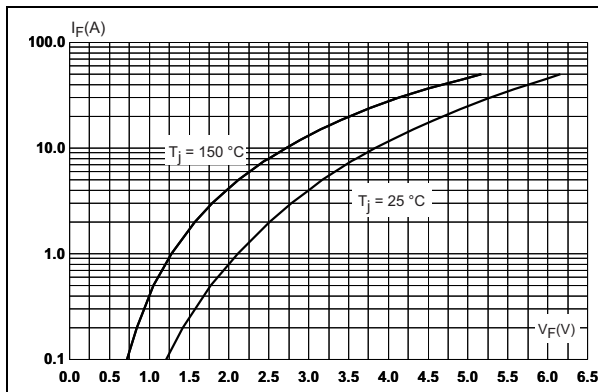

Figure 4. Relative variation of thermal impedance, junction to case, versus pulse duration

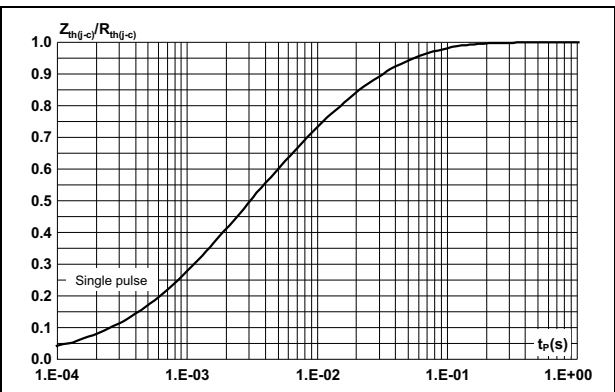

Figure 5. Peak reverse recovery current versus  $di_F/dt$  (typical values)

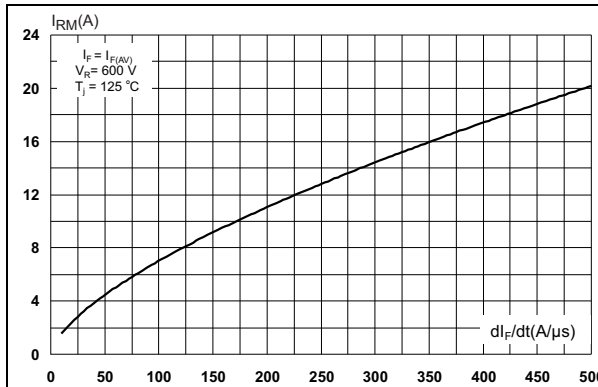

Figure 6. Reverse recovery time versus  $di_F/dt$  (typical values)

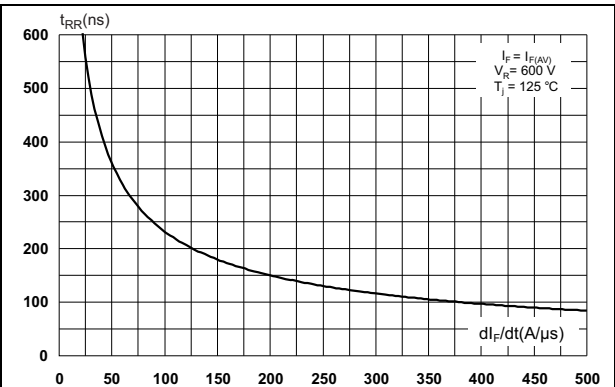

Figure 7. Reverse recovery charges versus  $di_F/dt$  (typical values)

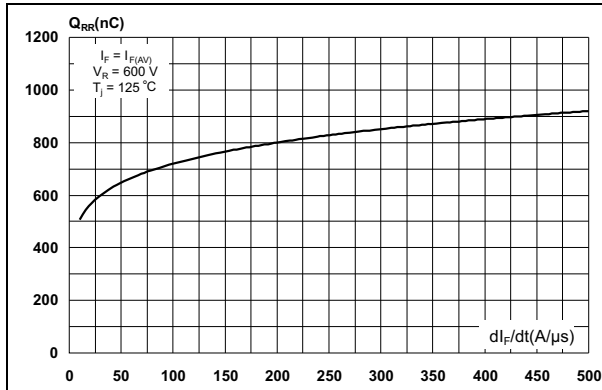

Figure 8. Reverse recovery softness factor versus  $di_F/dt$  (typical values)

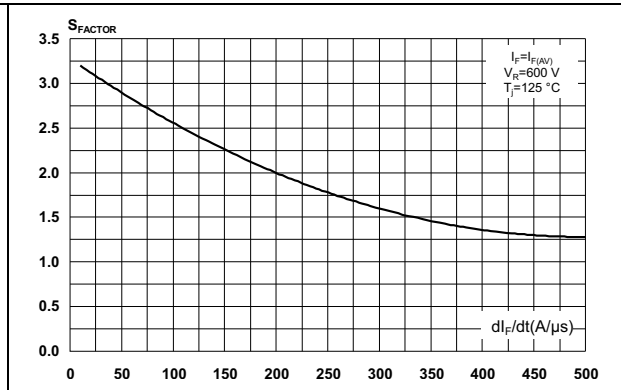

Figure 9. Relative variations of dynamic parameters versus junction temperature

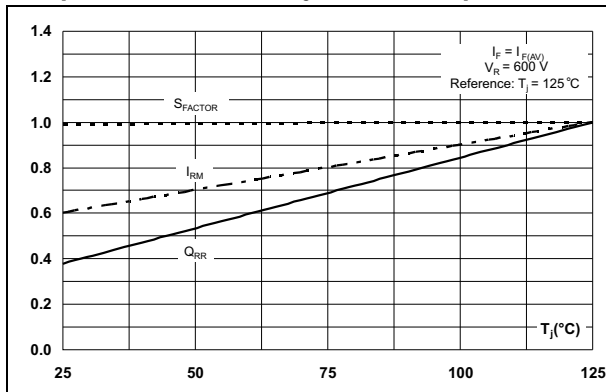
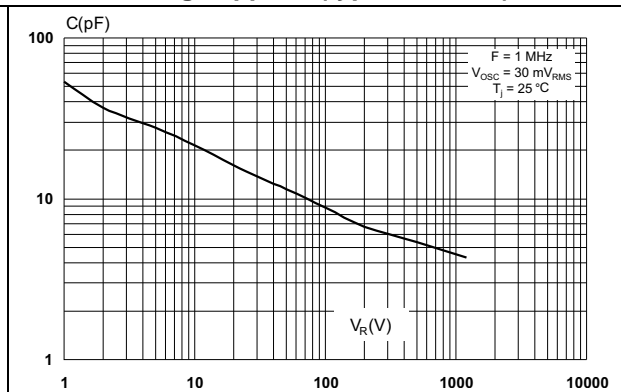

Figure 10. Junction capacitance versus reverse voltage applied (typical values)



## 2 Package information

- Epoxy meets UL94, V0
- Cooling method: by conduction (C)
- Recommended torque value: 0.4 N·m to 0.6 N·m

In order to meet environmental requirements, ST offers these devices in different grades of ECOPACK<sup>®</sup> packages, depending on their level of environmental compliance. ECOPACK<sup>®</sup> specifications, grade definitions and product status are available at: [www.st.com](http://www.st.com). ECOPACK<sup>®</sup> is an ST trademark.

Figure 11. T0-220AC dimension definitions

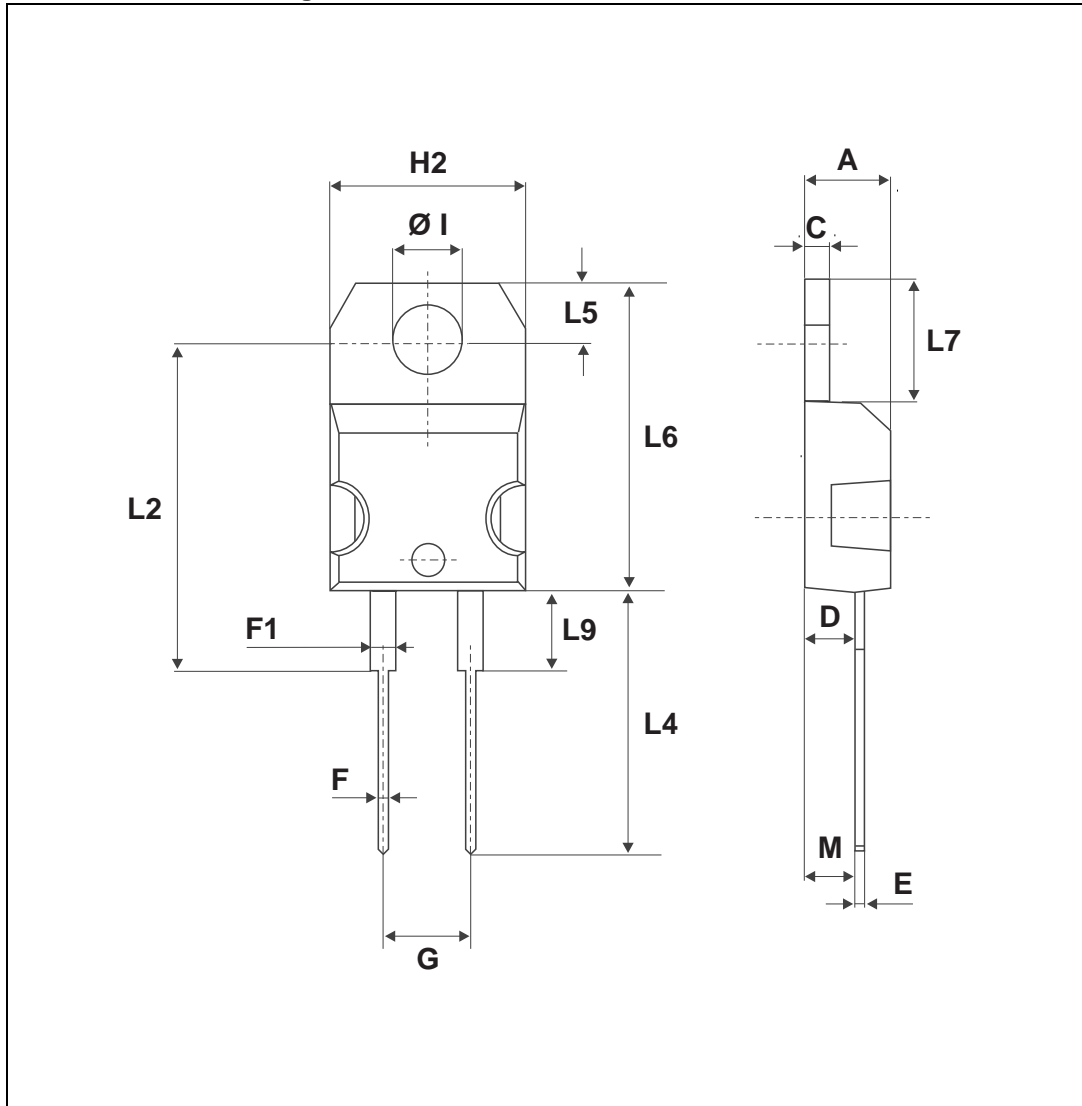

Table 6. T0-220AC dimension values

Ref.	Dimensions					
	Millimeters			Inches		
	Min.	Typ.	Max.	Min.	Typ.	Max.
A	4.40		4.60	0.173		0.181
C	1.23		1.32	0.048		0.051
D	2.40		2.72	0.094		0.107
E	0.49		0.70	0.019		0.027
F	0.61		0.88	0.024		0.034
F1	1.14		1.70	0.044		0.066
G	4.95		5.15	0.194		0.202
H2	10.00		10.40	0.393		0.409
L2		16.40			0.645	
L4	13.00		14.00	0.511		0.551
L5	2.65		2.95	0.104		0.116
L6	15.25		15.75	0.600		0.620
L7	6.20		6.60	0.244		0.259
L9	3.5		3.93	0.137		0.154
M		2.6			0.102	
Diam. I	3.75		3.85	0.147		0.151

### 3 Ordering information

Table 7. Ordering information

Order code	Marking	Package	Weight	Base qty	Delivery mode
STTH8S12D	STTH8S12D	TO-220AC	1.9 g	50	Tube

### 4 Revision history

Table 8. Document revision history

Date	Revision	Changes
18-Sep-2014	1	Initial release

**IMPORTANT NOTICE – PLEASE READ CAREFULLY**

STMicroelectronics NV and its subsidiaries ("ST") reserve the right to make changes, corrections, enhancements, modifications, and improvements to ST products and/or to this document at any time without notice. Purchasers should obtain the latest relevant information on ST products before placing orders. ST products are sold pursuant to ST's terms and conditions of sale in place at the time of order acknowledgement.

Purchasers are solely responsible for the choice, selection, and use of ST products and ST assumes no liability for application assistance or the design of Purchasers' products.

No license, express or implied, to any intellectual property right is granted by ST herein.

Resale of ST products with provisions different from the information set forth herein shall void any warranty granted by ST for such product.

ST and the ST logo are trademarks of ST. All other product or service names are the property of their respective owners.

Information in this document supersedes and replaces information previously supplied in any prior versions of this document.

© 2014 STMicroelectronics – All rights reserved



# Mouser Electronics

Authorized Distributor

Click to View Pricing, Inventory, Delivery & Lifecycle Information:

[STMicroelectronics:](#)

[STTH8S12D](#)