

Ambient Light Sensor ICs

Digital 16bit Serial Output Type Ambient Light Sensor IC



BH1715FVC

No.10046EBT06

●Descriptions

BH1715FVC is an digital Ambient Light Sensor IC for I²C bus interface. BH1715FVC is the most suitable to obtain the ambient light data for adjusting LCD and Keypad backlight power of Mobile phone. It is possible to detect wide range at High resolution. (1 - 65535 lx).

●Features

- 1) I²C bus Interface (f / s Mode Support)
- 2) Spectral responsibility is approximately human eye response
- 3) Illuminance to Digital Converter
- 4) Wide range and High resolution. (1 - 65535 lx)
- 5) Low Current by power down function
- 6) 50Hz / 60Hz Light noise reject-function
- 7) 1.8V Logic input interface
- 8) No need any external parts
- 9) Light source dependency is little.
(ex. Incandescent Lamp. Fluorescent Lamp. Halogen Lamp. White LED. Sun Light)
- 10) It is possible to select 2 type of I²C slave-address.
- 11) Adjustable measurement result for influence of optical window
(It is possible to detect min. 0.23 lx, max. 100000 lx by using this function.)
- 12) Small measurement variation (+/- 15%)

●Applications

Mobile phone, LCD TV, NOTE PC, Portable game machine, Digital camera, Digital video camera, Car navigation, PDA, LCD display

●Absolute Maximum Ratings

Parameter	Symbol	Ratings	Units
Supply Voltage	V _{max}	4.5	V
Operating Temperature	T _{opr}	-40~85	°C
Storage Temperature	T _{stg}	-40~100	°C
SDA Sink Current	I _{max}	7	mA
Power Dissipation	P _d	260*	mW

* 70mm × 70mm × 1.6mm glass epoxy board. Derating in done at 3.47mW/°C for operating above Ta=25°C.

●Operating Conditions

Parameter	Symbol	Ratings			Units
		Min.	Typ.	Max.	
V _{CC} Voltage	V _{CC}	2.4	3.0	3.6	V
I ² C Reference Voltage	V _{DVI}	1.65	—	V _{CC}	V

● **Electrical Characteristics** ($V_{CC} = 3.0V$, $DVI = 3.0V$, $T_a = 25^{\circ}C$, unless otherwise noted)

Parameter	Symbol	Limits			Units	Conditions
		Min.	Typ.	Max.		
Supply Current	Icc1	—	120	190	μA	$E_v = 100 \text{ lx}^{\ast 1}$
Powerdown Current	Icc2	—	0.01	1.0	μA	No input Light
Peak Wave Length	λ_p	—	560	—	nm	
Measurement Accuracy	S/A	1.02	1.2	1.38	times	Sensor out / Actual lx $E_v = 1000 \text{ lx}^{\ast 1, \ast 2}$
Dark (0 lx) Sensor out	S0	0	0	2	count	H-Resolution Mode $\ast 3$
H-Resolution Mode Resolution	rHR	—	1	—	lx	
L-Resolution Mode Resolution	rLR	—	4	—	lx	
H-Resolution Mode Measurement Time	tHR	—	120	180	ms	
L-Resolution Mode Measurement Time	tLR	—	16	24	ms	
Incandescent / Fluorescent Sensor out ratio	rIF	—	1	—	times	$E_v = 1000 \text{ lx}$
ADDR Input 'H' Voltage	VAH	$0.7 \cdot V_{CC}$	—	—	V	
ADDR Input 'L' Voltage	VAL	—	—	$0.3 \cdot V_{CC}$	V	
DVI Input 'L' Voltage	VDVL	—	—	0.4	V	
SCL, SDA Input 'H' Voltage 1	VIH1	$0.7 \cdot DVI$	—	—	V	$DVI \geq 1.8V$
SCL, SDA Input 'H' Voltage 2	VIH2	1.26	—	—	V	$1.65V \leq DVI < 1.8V$
SCL, SDA Input 'L' Voltage 1	VIL1	—	—	$0.3 \cdot DVI$	V	$DVI \geq 1.8V$
SCL, SDA Input 'L' Voltage 2	VIL2	—	—	$DVI - 1.26$	V	$1.65V \leq DVI < 1.8V$
SCL, SDA, ADDR Input 'H' Current	I _{IH}	—	—	10	μA	
SCL, SDA, ADDR Input 'L' Current	I _{IL}	—	—	10	μA	
I ² C SCL Clock Frequency	f _{SCL}	—	—	400	kHz	
I ² C Bus Free Time	t _{BUF}	1.3	—	—	μs	
I ² C Hold Time (repeated) START Condition	t _{HDSTA}	0.6	—	—	μs	
I ² C Set up time for a Repeated START Condition	t _{SUSTA}	0.6	—	—	μs	
I ² C Set up time for a Repeated STOP Condition	t _{SUSTD}	0.6	—	—	μs	
I ² C Data Hold Time	t _{HDDAT}	0	—	0.9	μs	
I ² C Data Setup Time	t _{SUDAT}	100	—	—	ns	
I ² C 'L' Period of the SCL Clock	t _{LOW}	1.3	—	—	μs	
I ² C 'H' Period of the SCL Clock	t _{HIGH}	0.6	—	—	μs	
I ² C SDA Output 'L' Voltage	VOL	0	—	0.4	V	IOL = 3 mA

$\ast 1$ White LED is used as optical source.

$\ast 2$ Measurement Accuracy typical value is possible to change '1' by "Measurement result adjustment function".

$\ast 3$ Use H-Resolution Mode if dark data (less than 10 lx) is need.

●Reference Data

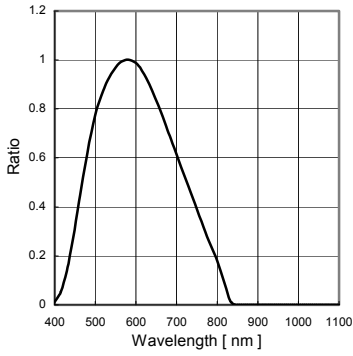

Fig.1 Spectral Response

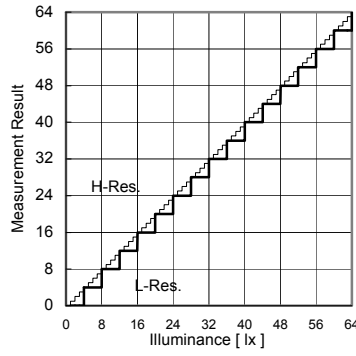

Fig.2 Illuminance – Measurement Result 1

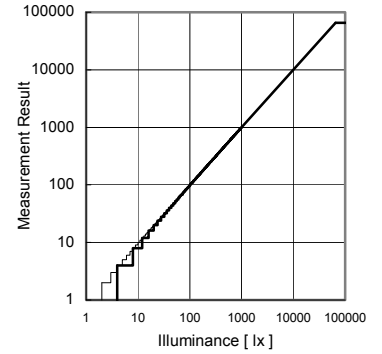

Fig.3 Illuminance – Measurement Result 2

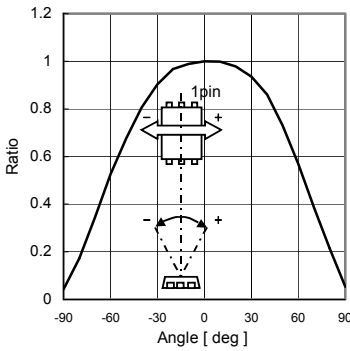

Fig.4 Directional Characteristics 1

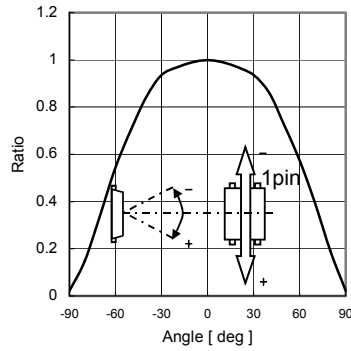

Fig.5 Directional Characteristics 2

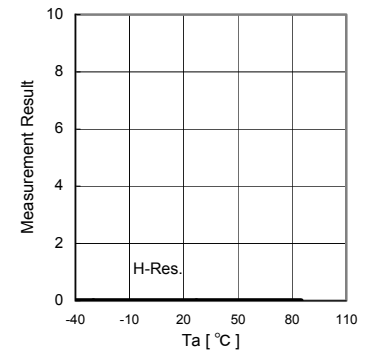

Fig.6 Dark Response

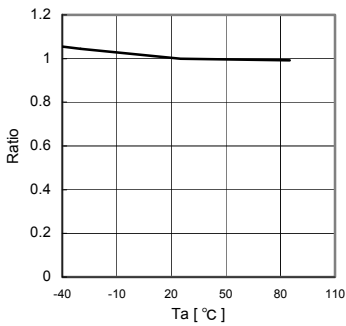

Fig.7 Measurement Result Temperature Dependency

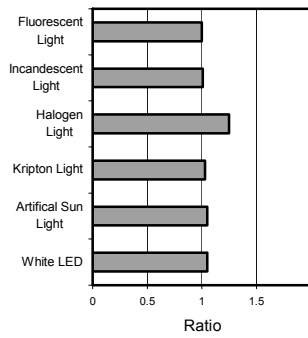

Fig.8 Light Source Dependency (Fluorescent Light is set to '1')

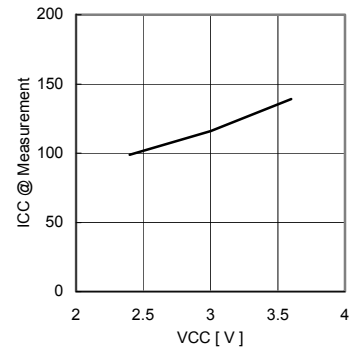

Fig.9 $V_{CC} - I_{CC}$ (During measurement)

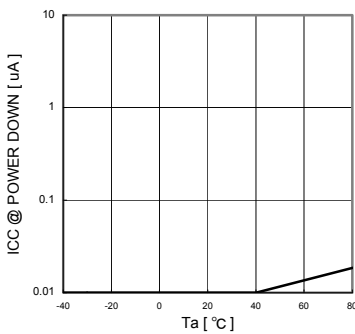

Fig.10 $V_{CC} - I_{CC}@0 Lx$ (POWER DOWN)

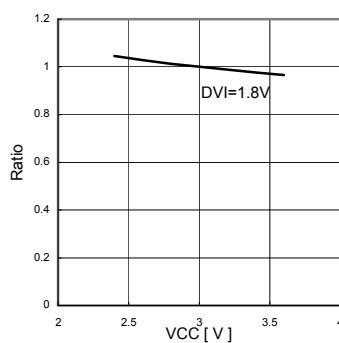

Fig.11 Measurement Result VCC Dependency

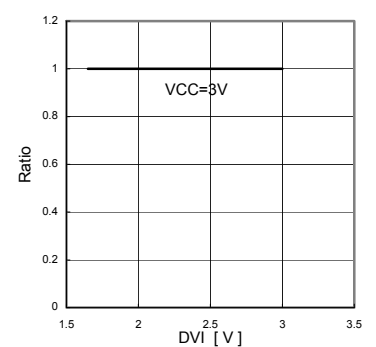
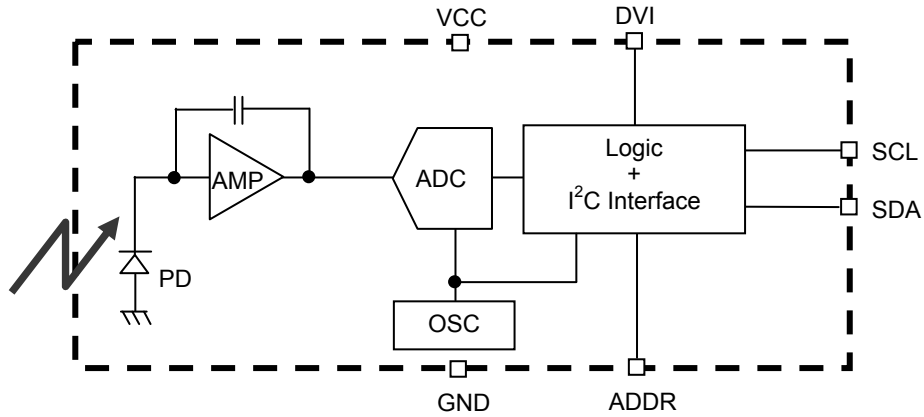

Fig.12 Measurement Result DVI Dependency

●Block Diagram



●Block Diagram Descriptions

- PD
Photo diode with approximately human eye response.
- AMP
Integration-OPAMP for converting from PD current to Voltage.
- ADC
AD converter for obtainment Digital 16bit data.
- Logic + I²C Interface
Ambient Light Calculation and I²C BUS Interface. It is including below register.
Data Register → This is for registration of Ambient Light Data. Initial Value is "0000_0000_0000_0000".
Measurement Time Register → This is for registration of measurement time. Initial Value is "0100_0101".
- OSC
Internal Oscillator (typ. 320kHz). It is CLK for internal logic.

●Measurement Procedure

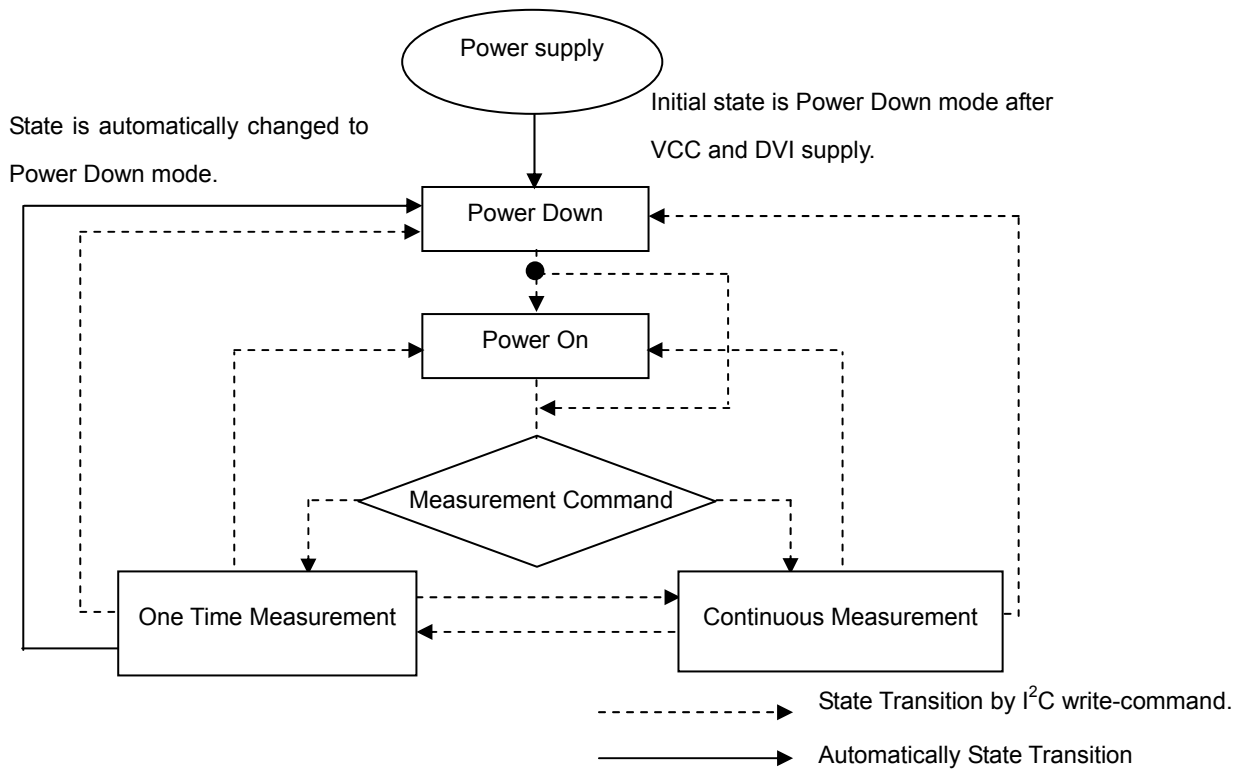

* "Power On" Command is possible to omit.

● Instruction Set Architecture

Instruction	Opecode	Comments
Power Down	0000_0000	No active state.
Power On	0000_0001	Waiting for measurement command.
Reset	0000_0111	Reset Data register value. Reset command is not acceptable in Power Down mode.
Continuously H-Resolution Mode	0001_0000	Start measurement at 1lx resolution. Measurement Time is typically 120ms.
Continuously L-Resolution Mode	0001_0011	Start measurement at 4lx resolution. Measurement Time is typically 16ms.
One Time H-Resolution Mode	0010_0000	Start measurement at 1lx resolution. Measurement Time is typically 120ms. It is automatically set to Power Down mode after measurement.
One Time L-Resolution Mode	0010_0011	Start measurement at 4lx resolution. Measurement Time is typically 16ms. It is automatically set to Power Down mode after measurement.
Change Measurement time (High bit)	01000_MT[7,6,5]	Change measurement time. ※ Please refer "adjust measurement result for influence of optical window."
Change Measurement time (Low bit)	011_MT[4,3,2,1,0]	Change measurement time. ※ Please refer "adjust measurement result for influence of optical window."

※ Don't input the other opecode.

● Measurement mode explanation

Measurement Mode	Measurement Time.	Resolution
H-Resolution Mode	Typ. 120ms.	1 Lx.
L-Resolution Mode	Typ. 16ms.	4 Lx.

We recommend to use H-Resolution Mode.

Measurement time (integration time) of H-Resolution Mode is so long that some kind of noise(including in 50Hz / 60Hz noise) is rejected. And H-Resolution Mode is 1 lx resolution so that it is suitable for darkness (less than 10 lx)

● Explanation of Asynchronous reset and Reset command "0000_0111"

1) Asynchronous reset

All registers are reset. It is necessary on power supply sequence. Please refer "Timing chart for VCC and DVI power supply sequence" in this page. It is power down mode during DVI = 'L'.

2) Reset command

Reset command is for only reset Illuminance data register. (reset value is '0') It is not necessary even power supply sequence. It is used for removing previous measurement result. This command is not working in power down mode, so that please set the power on mode before input this command.

●Timing chart for VCC and DVI power supply sequence

DVI is I²C bus reference voltage terminal. And it is also asynchrono reset terminal. It is necessary to set to 'L' after VCC is supplied. In DVI 'L' term, internal state is set to Power Down mode.

1) Recommended Timing chart1 for VCC and DVI supply.

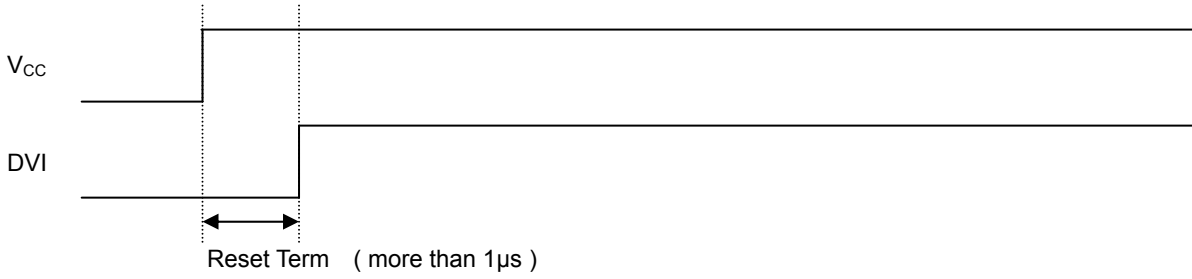

2)Timing chart2 for VCC and DVI supply.
(If DVI rises within 1us after VCC supply)

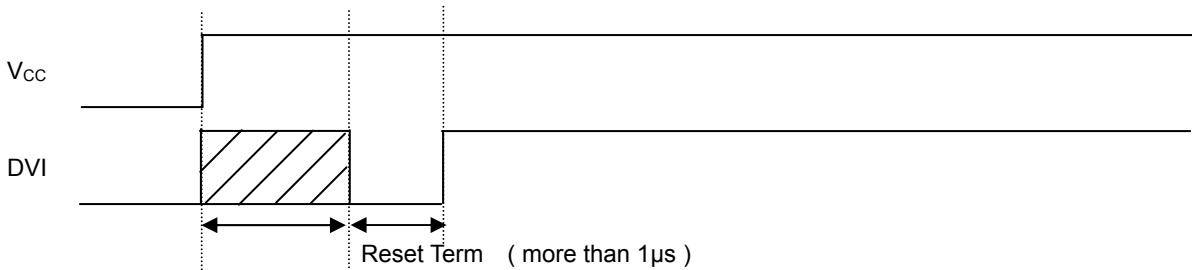

Don't care state

ADDR, SDA, SCL is not stable if DVI 'L' term (1µs) is not given by systems.

In this case, please connect the resisters (approximately 100kOhm) to ADDR without directly connecting to VCC or GND,because it is 3 state buffer for Internal testing.

●Measurement sequence example from "Write instruction" to "Read measurement result"

ex1) Continuously H-resolution mode (ADDR = 'L')



① Send "Continuously H-resolution mode " instruction

ST	0100011	0	Ack	00010000	Ack	SP
----	---------	---	-----	----------	-----	----

② Wait to complete 1st H-resolution mode measurement.(max. 180ms.)

③ Read measurement result.

ST	0100011	1	Ack	High Byte [15:8]	Ack
----	---------	---	-----	--------------------	-----

Low Byte [7:0]	Ack	SP
------------------	-----	----

How to calculate when the data High Byte is "10000011" and Low Byte is "10010000"
 $(2^{15} + 2^9 + 2^8 + 2^7 + 2^4) / 1.2 \doteq 28067 [lx]$

The result of continuously measurement mode is updated.(120ms.typ at H-resolution mode, 16ms.typ at L-resolution mode)

ex2) One time L-resolution mode (ADDR = 'H')

① Send "One time L-resolution mode " instruction

ST	1011100	0	Ack	00100011	Ack	SP
----	---------	---	-----	----------	-----	----

② Wait to complete L-resolution mode measurement.(max. 24ms.)

③ Read measurement result

ST	1011100	1	Ack	High Byte [15:8]	Ack
----	---------	---	-----	--------------------	-----

Low Byte [7:0]	Ack	SP
------------------	-----	----

How to calculate when the data High Byte is "00000001" and Low Byte is "00010000"
 $(2^8 + 2^4) / 1.2 \doteq 227 [lx]$

In one time measurement, Statement moves to power down mode after measurement completion. If updated result is need then please resend measurement instruction.

●Application circuit example of DVI terminal

The DVI terminal is an asynchronous reset terminal. Please note that there is a possibility that IC doesn't operate normally if the reset section is not installed after the start-up of VCC. (Please refer to the paragraph of "Timing chart for VCC and DVI power supply sequence")

The description concerning SDA and the terminal SCL is omitted in this application circuit example. Please design the application the standard of the I²C bus as it finishes being satisfactory. Moreover, the description concerning the terminal ADDR is omitted. Please refer to the paragraph of "Timing chart for VCC and DVI power supply sequence" about the terminal ADDR design.

ex 1) The control signal line such as CPU is connected.

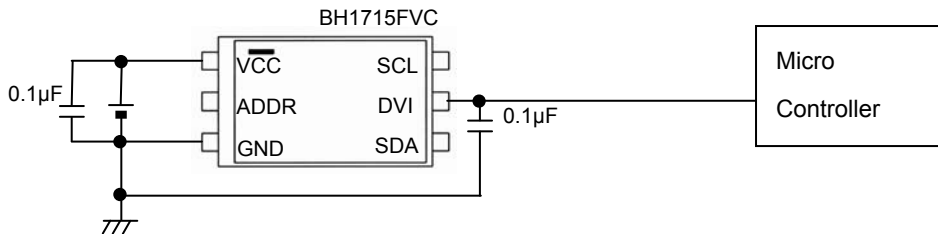

ex 2) Reset IC is used.

1, For Reset IC of the Push-Pull type

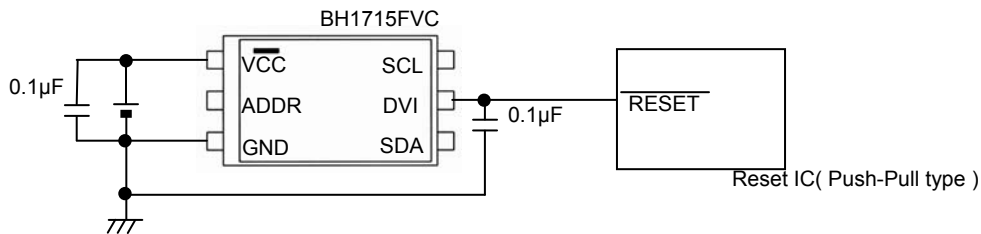

2, For Reset IC of the Open drain output

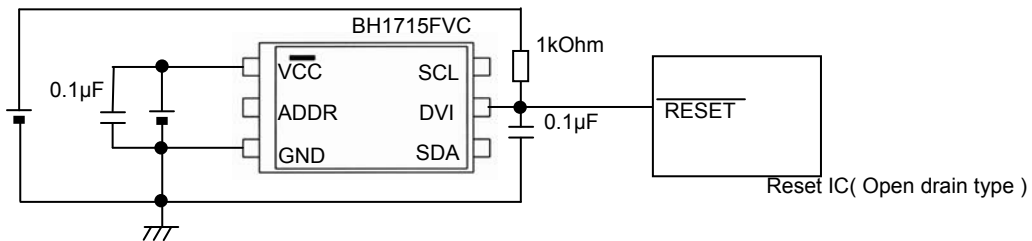

ex 3) A different power supply is used.

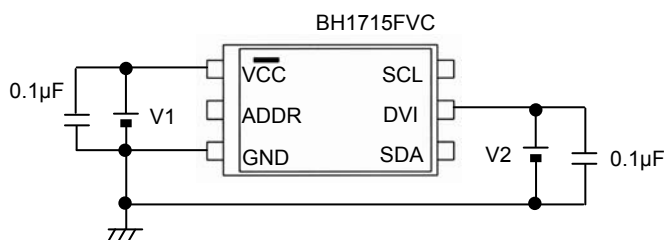

※ Power supply of DVI must stand up later than power supply of VCC stand up, because it is necessary to secure reset section (1µs or more).

ex 4) LPF using CR is inserted between VCC and DVI.

This method has the possibility that the Reset section of turning on the power supply can not satisfied. cannot be satisfied. Please design the set considering the characteristic of the power supply enough.

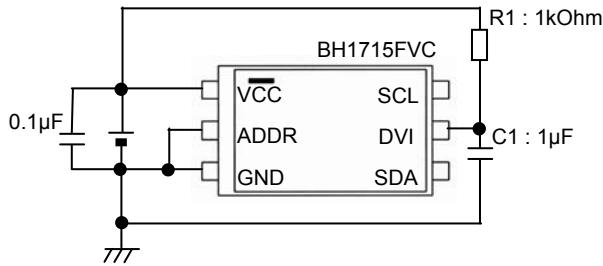

◆ Notes when CR is inserted between VCC and DVI

- ※ Please note that there is a possibility that reset section (1µs) can not be satisfied because the power supply is turned on when the rise time of VCC is slow
- ※ When VCC is turned off, the DVI voltage becomes higher than VCC voltage but IC destruction is not occurred if recommended constant (R1 = 1kOhm, C1 = 1µF) is used.
- ※ Please note that there is a possibility that Reset section (1µsec) cannot be satisfied if wait time is not enough long after turning off VCC. (It is necessary to consider DVI voltage level after turning off VCC.)

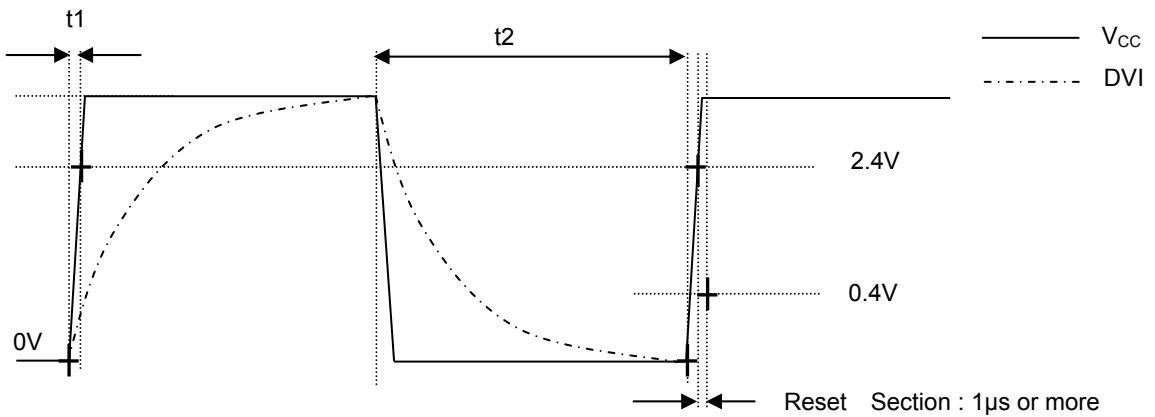

*Please do the application design to secure Reset section 1µs or more after the reclosing of the power supply.

◆ Example of designing set when CR (C = 1µF, R = 1kΩ) is inserted between VCC and DVI with VCC=2.8V

- ① The rise time to 0→2.4V of VCC must use the power supply of 100µs or less.
- ② Please wait 25ms or more after VCC turn off (VCC <= 0.05V), because it is necessary to secure reset section (1µs or more).

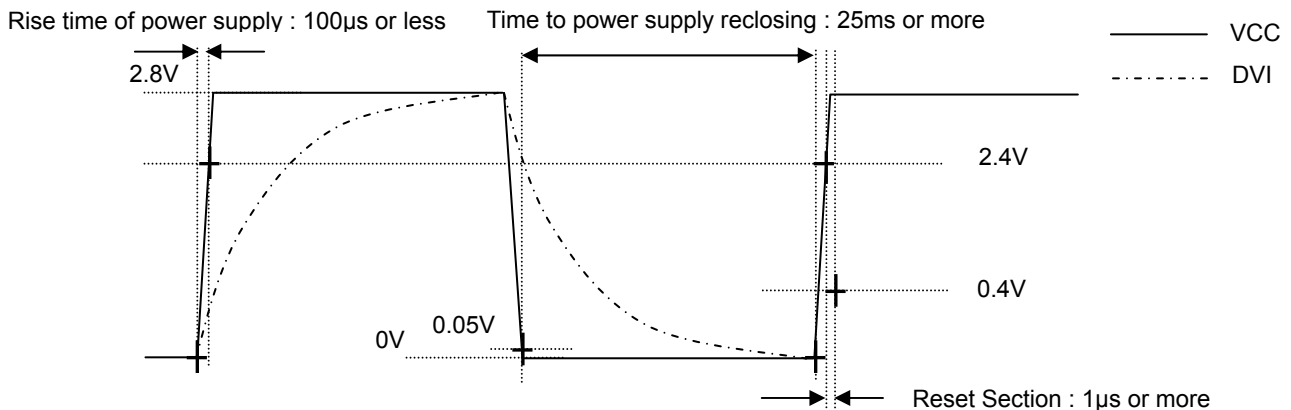

* Please do the application design to secure Reset section 1µs or more after the reclosing of the power supply.

● I²C Bus Access

1) I²C Bus Interface Timing chart

Write measurement command and Read measurement result are done by I²C Bus interface. Please refer the formally specification of I²C Bus interface, and follow the formally timing chart.

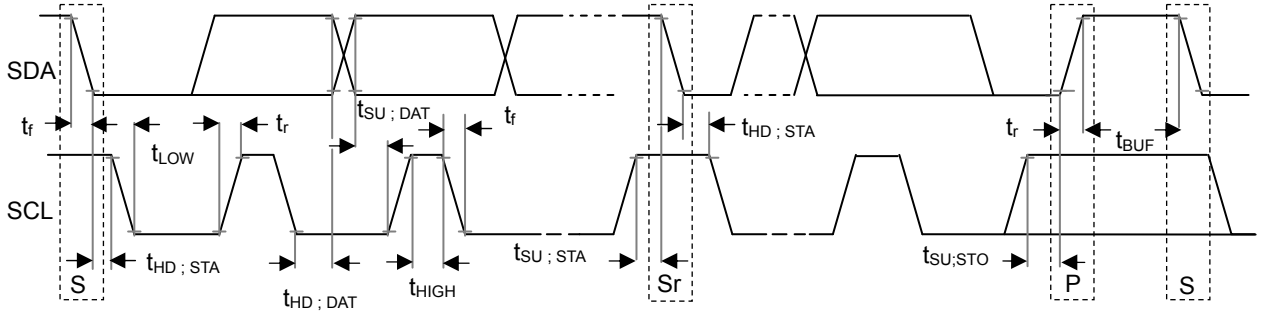

2) Slave Address

Slave Address is 2 types, it is determined by ADDR Terminal

- ADDR = 'H' ($ADDR \geq 0.7V_{CC}$) → "1011100"
- ADDR = 'L' ($ADDR \leq 0.3V_{CC}$) → "0100011"

3) Write Format

BH1715FVC is not able to accept plural command without stop condition. Please insert SP every 1 Opecode.

ST	Slave Address	R/W 0	Ack	Opecode	Ack	SP
----	---------------	----------	-----	---------	-----	----

4) Read Format

ST	Slave Address	R/W 1	Ack	High Byte [15:8] $2^{15} \ 2^{14} \ 2^{13} \ 2^{12} \ 2^{11} \ 2^{10} \ 2^9 \ 2^8$	Ack
----	---------------	----------	-----	---	-----

$2^7 \ 2^6 \ 2^5 \ 2^4 \ 2^3 \ 2^2 \ 2^1 \ 2^0$	Low Byte [7:0]	Ack	SP
---	----------------	-----	----



from Master to Slave



from Slave to Master

ex)

High Byte = "1000_0011"

Low Byte = "1001_0000"

$$(2^{15} + 2^9 + 2^8 + 2^7 + 2^4) / 1.2 \doteq 28067 [Ix]$$

* Please refer formality I²C bus specification of NXP semiconductors.

●Adjust measurement result for influence of optical window. (sensor sensitivity adjusting)

BH1715FVC is possible to change sensor sensitivity. And it is possible to cancel the optical window influence (difference with / without optical window) by using this function. Adjust is done by changing measurement time. For example, when transmission rate of optical window is 50% (measurement result becomes 0.5 times if optical window is set), influence of optical window is ignored by changing sensor sensitivity from default to 2 times

Sensor sensitivity is shift by changing the value of MTreg (measurement time regisiter). MTreg value has to set 2 times if target of sensor sensitivity is 2 times. Measurement time is also set 2 times when MTreg value is changed from default to 2 times.

ex) Procedure for changing target sensor sensitivity to 2 times.
Please change Mtrege from "0100_0101" (default) to "1000_1010" (default * 2).

1) Changing High bit of Mtrege

ST	Slave Address	R/W 0	Ack	01000_100	Ack	SP
----	---------------	----------	-----	-----------	-----	----

2) Changing Low bit of Mtrege

ST	Slave Address	R/W 0	Ack	011_01010	Ack	SP
----	---------------	----------	-----	-----------	-----	----

3) Input Measurement Command.

ST	Slave Address	R/W 0	Ack	0001_0000	Ack	SP
----	---------------	----------	-----	-----------	-----	----

※This example is High Resolution mode, but it accepts the other measurement.

4) After about 240ms, measurement result is registered to Data Register.
(High Resolution mode is typically 120ms, but measurement time is set twice.)

The below table is seeing the changable range of MTreg.

		Min.	Typ.	Max.
changable range of MTreg	binary	0001_1111 (sensitivity : default * 0.45)	0100_0101 default	1111_1110 (sensitivity : default * 3.68)
	decimal	31 (sensitivity : default * 0.45)	69 default	254 (sensitivity : default * 3.68)

It is possilbe to detect 0.23lx by using this function at H-resolution mode.

The below formula is to calculate illuminance per 1 count.

$$\text{Illuminance per 1 count (lx / count)} = 1 / 1.2 * (69 / X)$$

1.2 : Measurement accuracy

69 : Default value of MTreg (dec)

X : MTreg value

The below table is seeing the detail of resolution.

MTreg value	lx / count
0001_1111	1.85
0100_0101	0.83
1111_1110	0.23

● Terminal Description

Pin No.	Terminal Name	Equivalent Circuit	Function
1	VCC		Power Supply Terminal
2	ADDR		<p>I^2C Slave-address Terminal ADDR = 'H' ($ADDR \geq 0.7V_{CC}$) "1011100" ADDR = 'L' ($ADDR \leq 0.3V_{CC}$) "0100011" ADDR Terminal is designed as 3 state buffer for internal test. So that please take care of V_{CC} and DVI supply procedure. Please see P6.</p>
3	GND		GND Terminal
4	SDA		I^2C bus Interface SDA Terminal
5	DVI		<p>SDA, SCL Reference Voltage Terminal And DVI Terminal is also asynchronous Reset for internal registers. So that please set to 'L' (at least $1\mu s$, $DVI \leq 0.4V$) after V_{CC} is supplied. BH1715FVC is pulled down by 150kOhm while $DVI = 'L'$.</p>
6	SCL		I^2C bus Interface SCL Terminal

※ These values are design-value, not guaranteed.

●Package Outlines

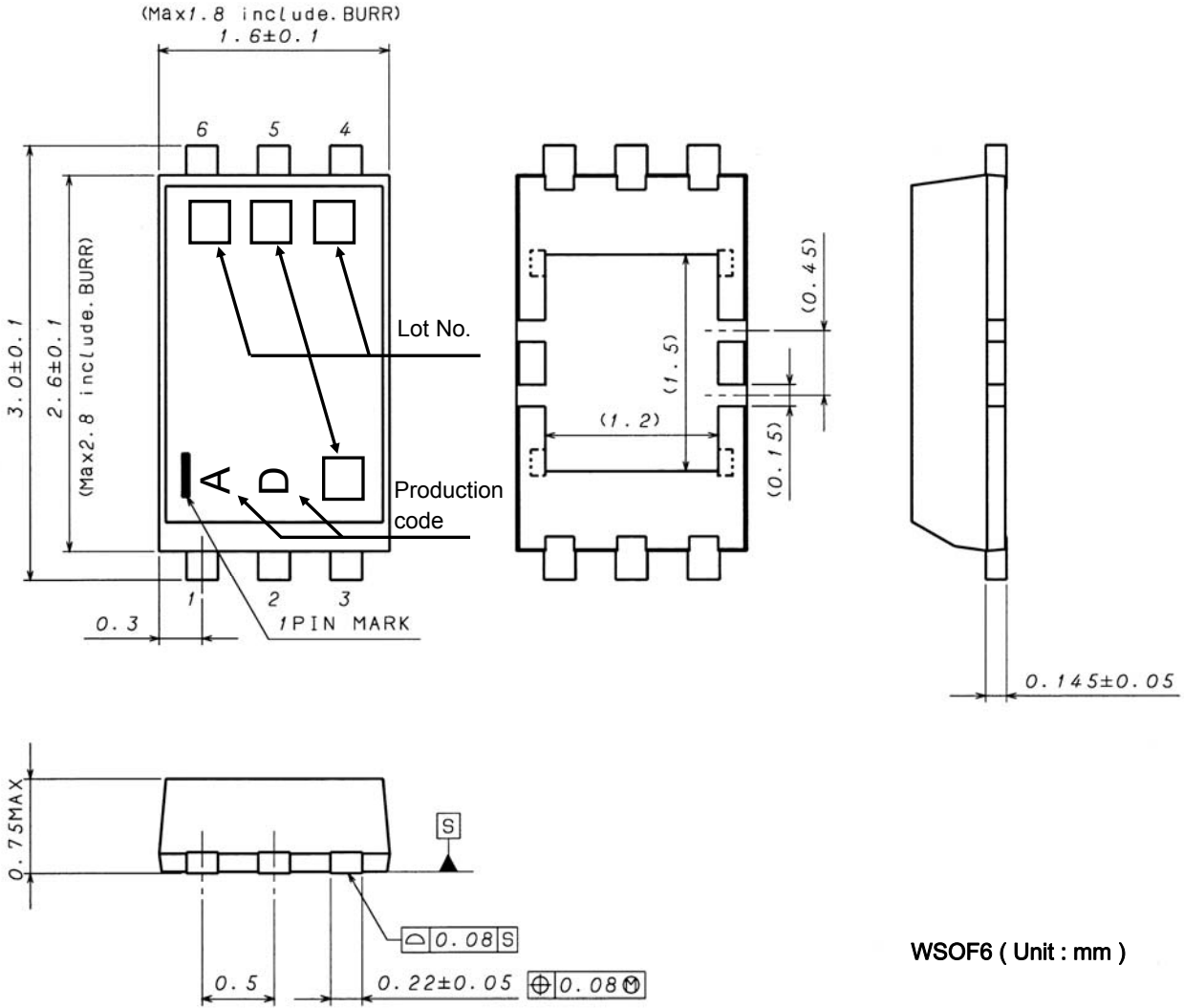

●About an optical design on the device

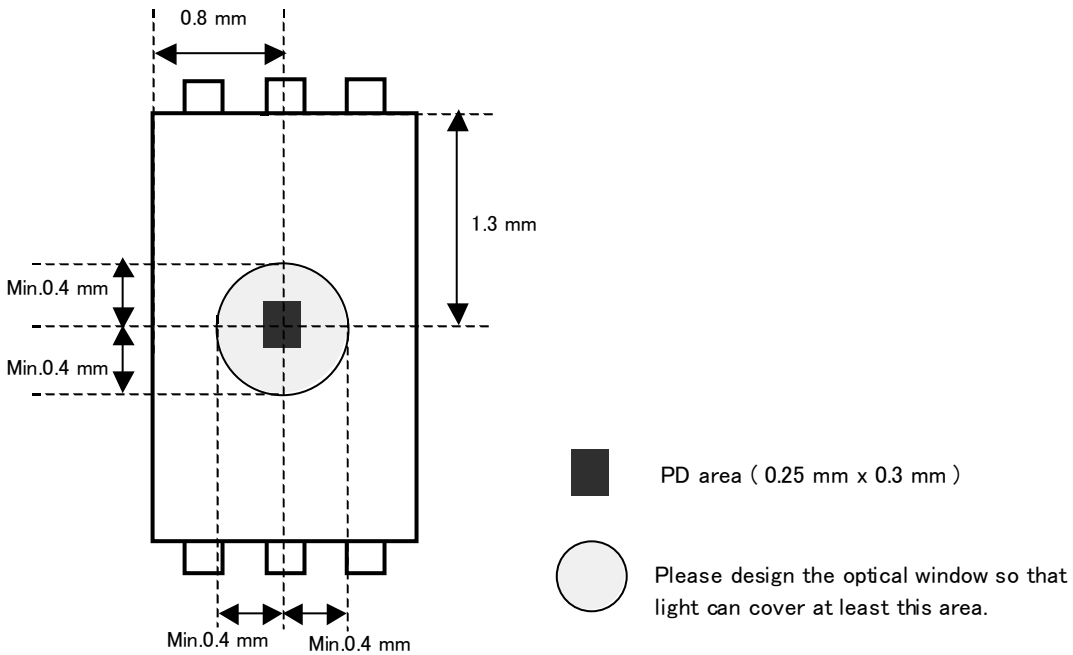

●The method of distinguishing 1pin

There is some method of distinguishing 1pin.

- ① Distinguishing by 1Pin wide-lead
- ② Distinguishing by die pattern
- ③ Distinguishing by taper part of 1-3pin side

② (by die pattern) is the easiest method to distinguish by naked eye.

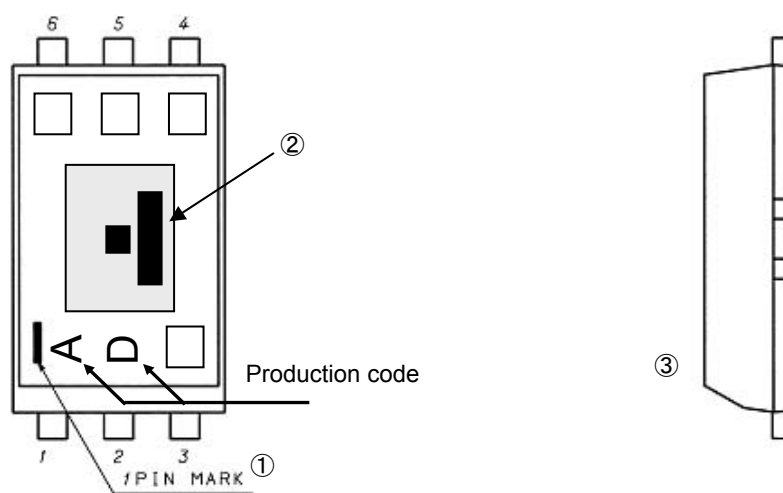

●Cautions on use

1) Absolute Maximum Ratings

An excess in the absolute maximum ratings, such as supply voltage (V_{max}), temperature range of operating conditions (T_{opr}), etc., can break down devices, thus making impossible to identify breaking mode such as a short circuit or an open circuit. If any special mode exceeding the absolute maximum ratings is assumed, consideration should be given to take physical safety measures including the use of fuses, etc.

2) GND voltage

Make setting of the potential of the GND terminal so that it will be maintained at the minimum in any operating state. Furthermore, check to be sure no terminals are at a potential lower than the GND voltage including an actual electric transient.

3) Short circuit between terminals and erroneous mounting

In order to mount ICs on a set PCB, pay thorough attention to the direction and offset of the ICs. Erroneous mounting can break down the ICs. Furthermore, if a short circuit occurs due to foreign matters entering between terminals or between the terminal and the power supply or the GND terminal, the ICs can break down.

4) Operation in strong electromagnetic field

Be noted that using ICs in the strong electromagnetic field can malfunction them.

5) Inspection with set PCB

On the inspection with the set PCB, if a capacitor is connected to a low-impedance IC terminal, the IC can suffer stress. Therefore, be sure to discharge from the set PCB by each process. Furthermore, in order to mount or dismount the set PCB to/from the jig for the inspection process, be sure to turn OFF the power supply and then mount the set PCB to the jig. After the completion of the inspection, be sure to turn OFF the power supply and then dismount it from the jig. In addition, for protection against static electricity, establish a ground for the assembly process and pay thorough attention to the transportation and the storage of the set PCB.

6) Input terminals

In terms of the construction of IC, parasitic elements are inevitably formed in relation to potential. The operation of the parasitic element can cause interference with circuit operation, thus resulting in a malfunction and then breakdown of the input terminal. Therefore, pay thorough attention not to handle the input terminals; such as to apply to the input terminals a voltage lower than the GND respectively, so that any parasitic element will operate. Furthermore, do not apply a voltage to the input terminals when no power supply voltage is applied to the IC. In addition, even if the power supply voltage is applied, apply to the input terminals a voltage lower than the power supply voltage or within the guaranteed value of electrical characteristics.

7) Thermal design

Perform thermal design in which there are adequate margins by taking into account the power dissipation (P_d) in actual states of use.

8) Treatment of package

Dusts or scratch on the photo detector may affect the optical characteristics. Please handle it with care.

9) Rush current

When power is first supplied to the CMOS IC, it is possible that the internal logic may be unstable and rush current may flow instantaneously. Therefore, give special consideration to power coupling capacitance, power wiring, width of GND wiring, and routing of connections.

10) The exposed central pad on the back side of the package

There is an exposed central pad on the back side of the package. But please do it non connection. (Don't solder, and don't do electrical connection) Please mount by Footprint dimensions described in the Jisso Information for WSOF6. This pad is GND level, therefore there is a possibility that LSI malfunctions and heavy-current is generated.

●Ordering part number

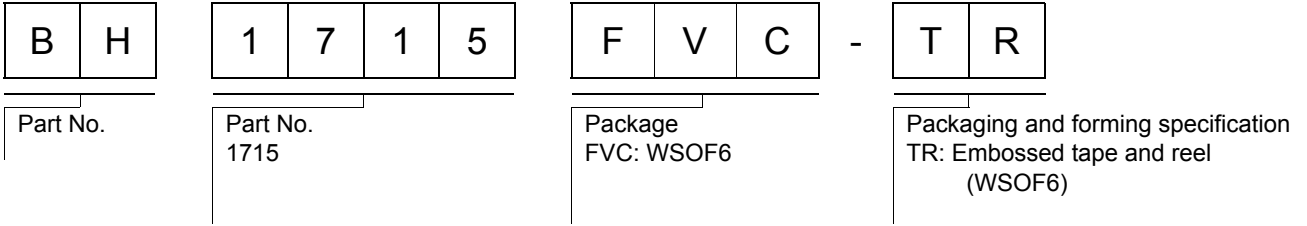

WSOF6

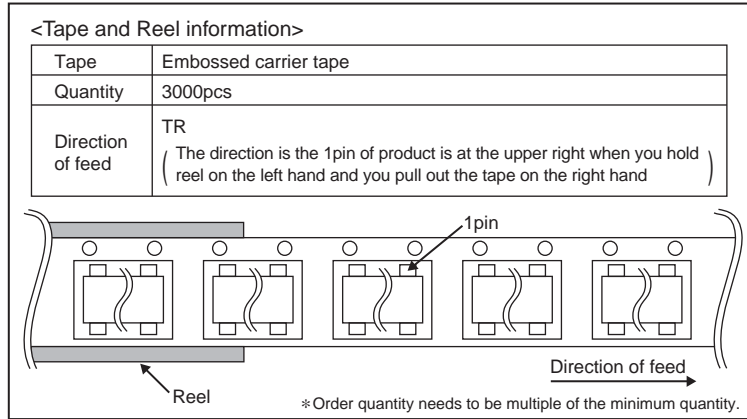
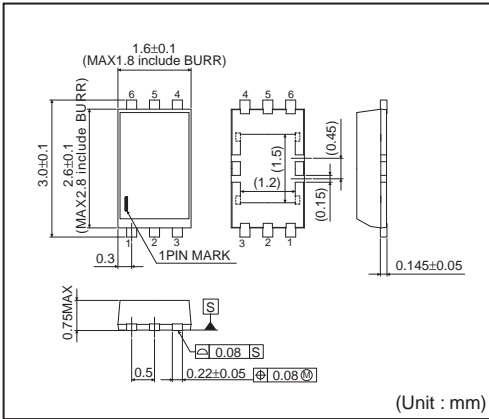

Notes

No copying or reproduction of this document, in part or in whole, is permitted without the consent of ROHM Co.,Ltd.

The content specified herein is subject to change for improvement without notice.

The content specified herein is for the purpose of introducing ROHM's products (hereinafter "Products"). If you wish to use any such Product, please be sure to refer to the specifications, which can be obtained from ROHM upon request.

Examples of application circuits, circuit constants and any other information contained herein illustrate the standard usage and operations of the Products. The peripheral conditions must be taken into account when designing circuits for mass production.

Great care was taken in ensuring the accuracy of the information specified in this document. However, should you incur any damage arising from any inaccuracy or misprint of such information, ROHM shall bear no responsibility for such damage.

The technical information specified herein is intended only to show the typical functions of and examples of application circuits for the Products. ROHM does not grant you, explicitly or implicitly, any license to use or exercise intellectual property or other rights held by ROHM and other parties. ROHM shall bear no responsibility whatsoever for any dispute arising from the use of such technical information.

The Products specified in this document are intended to be used with general-use electronic equipment or devices (such as audio visual equipment, office-automation equipment, communication devices, electronic appliances and amusement devices).

The Products specified in this document are not designed to be radiation tolerant.

While ROHM always makes efforts to enhance the quality and reliability of its Products, a Product may fail or malfunction for a variety of reasons.

Please be sure to implement in your equipment using the Products safety measures to guard against the possibility of physical injury, fire or any other damage caused in the event of the failure of any Product, such as derating, redundancy, fire control and fail-safe designs. ROHM shall bear no responsibility whatsoever for your use of any Product outside of the prescribed scope or not in accordance with the instruction manual.

The Products are not designed or manufactured to be used with any equipment, device or system which requires an extremely high level of reliability the failure or malfunction of which may result in a direct threat to human life or create a risk of human injury (such as a medical instrument, transportation equipment, aerospace machinery, nuclear-reactor controller, fuel-controller or other safety device). ROHM shall bear no responsibility in any way for use of any of the Products for the above special purposes. If a Product is intended to be used for any such special purpose, please contact a ROHM sales representative before purchasing.

If you intend to export or ship overseas any Product or technology specified herein that may be controlled under the Foreign Exchange and the Foreign Trade Law, you will be required to obtain a license or permit under the Law.



Thank you for your accessing to ROHM product informations.
More detail product informations and catalogs are available, please contact us.

ROHM Customer Support System

<http://www.rohm.com/contact/>