



3-terminal filters

For power line

ACH series

ACH3218 type

ACH3218

[1207 inch]*

* Dimensions Code JIS[EIA]

Caution

**The products in this catalog is not recommended
to a new design**

Please refer to our Web site about replacement information.

REMINDERS FOR USING THESE PRODUCTS

Before using these products, be sure to request the delivery specifications.

SAFETY REMINDERS

Please pay sufficient attention to the warnings for safe designing when using these products.

REMINDERS

- The storage period is less than 12 months. Be sure to follow the storage conditions (Temperature: 5 to 40°C, Humidity: 10 to 75% RH or less).
If the storage period elapses, the soldering of the terminal electrodes may deteriorate.
- Do not use or store in locations where there are conditions such as gas corrosion (salt, acid, alkali, etc.).
- Before soldering, be sure to preheat components.
The preheating temperature should be set so that the temperature difference between the solder temperature and chip temperature does not exceed 150°C.
- Soldering corrections after mounting should be within the range of the conditions determined in the specifications.
If overheated, a short circuit, performance deterioration, or lifespan shortening may occur.
- When embedding a printed circuit board where a chip is mounted to a set, be sure that residual stress is not given to the chip due to the overall distortion of the printed circuit board and partial distortion such as at screw tightening portions.
- Self heating (temperature increase) occurs when the power is turned ON, so the tolerance should be sufficient for the set thermal design.
- Carefully lay out the coil for the circuit board design of the non-magnetic shield type.
A malfunction may occur due to magnetic interference.
- Use a wrist band to discharge static electricity in your body through the grounding wire.
- Do not expose the products to magnets or magnetic fields.
- Do not use for a purpose outside of the contents regulated in the delivery specifications.
- The products listed on this catalog are intended for use in general electronic equipment (AV equipment, telecommunications equipment, home appliances, amusement equipment, computer equipment, personal equipment, office equipment, measurement equipment, industrial robots) under a normal operation and use condition.
The products are not designed or warranted to meet the requirements of the applications listed below, whose performance and/or quality require a more stringent level of safety or reliability, or whose failure, malfunction or trouble could cause serious damage to society, person or property.
If you intend to use the products in the applications listed below or if you have special requirements exceeding the range or conditions set forth in the each catalog, please contact us.

- (1) Aerospace/Aviation equipment
- (2) Transportation equipment (cars, electric trains, ships, etc.)
- (3) Medical equipment
- (4) Power-generation control equipment
- (5) Atomic energy-related equipment
- (6) Seabed equipment
- (7) Transportation control equipment

- (8) Public information-processing equipment
- (9) Military equipment
- (10) Electric heating apparatus, burning equipment
- (11) Disaster prevention/crime prevention equipment
- (12) Safety equipment
- (13) Other applications that are not considered general-purpose applications

When designing your equipment even for general-purpose applications, you are kindly requested to take into consideration securing protection circuit/device or providing backup circuits in your equipment.

3-terminal filters

For power line

Product compatible with RoHS directive

Halogen-free

Compatible with lead-free solders

Overview of ACH3218 type

FEATURES

- T-type EMC filter that can be used for high-current circuits.
- Achieve excellent attenuation characteristics by using it for circuits with stable grounds.
- Does not require mounting space due to vertical mounting design, making it perfect for high-density circuits.
- Guaranteed temperature range is -40 to +125°C, so it can be used under severe environmental conditions.
- Use this product under reflow soldering conditions.

APPLICATION

- HE devices (TVs, VTRs, CD players, electronic musical instruments, PCs, etc.)
- OA equipment (Computers, terminals, facsimiles, etc.)
- FA equipment (Robots, NC machine tools, process controllers, etc.)
- AE equipment (Car navigation systems, ECUs, etc.)

PART NUMBER CONSTRUCTION

ACH	3218	-	223	-	T	001	
Series name	LxWxT Dimensions (mm)		Capacitance (pF)		Packaging style		Internal code
	3218	3.2x1.8x2.5	223	22000	T	Taping	001

OPERATING TEMPERATURE RANGE, PACKAGE QUANTITY, PRODUCT WEIGHT

Type	Temperature range		Package quantity (pieces/reel)	Individual weight (mg)
	Operating temperature (°C)	Storage temperature* (°C)		
ACH3218	-40 to +125	-40 to +125	1,000	70

* The Storage temperature range is for after the circuit board is mounted.

RoHS Directive Compliant Product: See the following for more details. <https://product.tdk.com/info/en/environment/rohs/index.html>

Halogen-free: Indicates that Cl content is less than 900ppm, Br content is less than 900ppm, and that the total Cl and Br content is less than 1500ppm.

⚠ Please be sure to request delivery specifications that provide further details on the features and specifications of the products for proper and safe use. Please note that the contents may change without any prior notice due to reasons such as upgrading.

ACH3218 type

RECOMMENDED REFLOW PROFILE

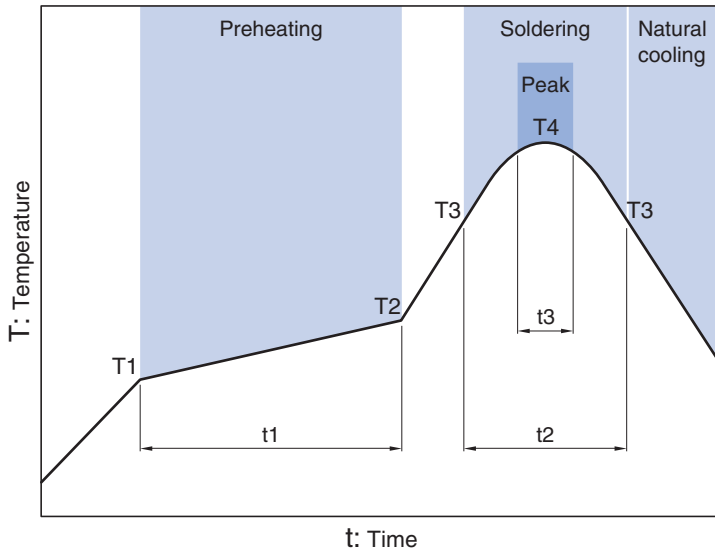

Preheating			Soldering		Peak	
Temp.		Time	Temp.	Time	Temp.	Time
T1	T2	t1	T3	t2	T4	t3
150°C	180°C	60 to 120s	230°C	30 to 60s	250 to 260°C	10s max.

ACH3218 type

■ SHAPE & DIMENSIONS

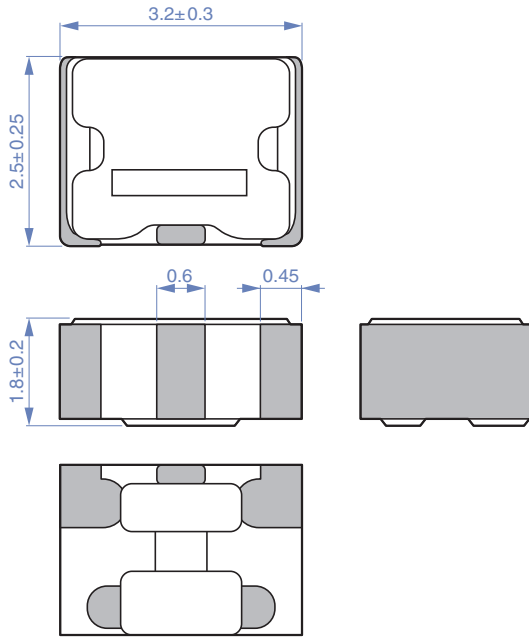

Dimensions in mm

■ RECOMMENDED LAND PATTERN

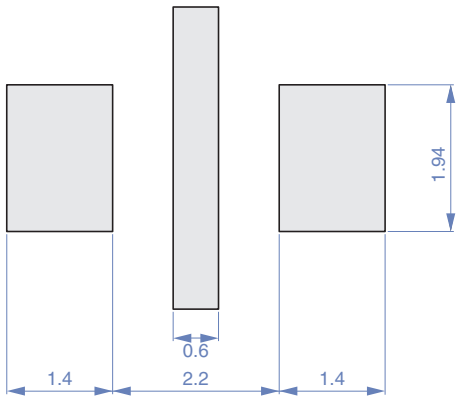

Dimensions in mm

■ CIRCUIT DIAGRAM

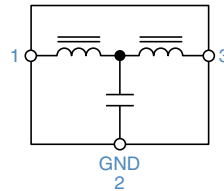

• No polarity

ACH3218 type

ELECTRICAL CHARACTERISTICS

CHARACTERISTICS SPECIFICATION TABLE

Insertion loss 25dB frequency range (MHz)	Rated voltage (V)max.	Rated current (A)max.	DC resistance [Terminal No.1 to 3] (Ω)max.	Insulation resistance [Terminal No.1 to 2/No.2 to 3] (MΩ)min.	Part No.
11 to 55	20	1.5	0.06	1000	ACH3218-223-T001
17 to 60	20	1.5	0.06	1000	ACH3218-103-T001
22 to 75	20	1.5	0.06	1000	ACH3218-682-T001
30 to 85	20	1.5	0.06	1000	ACH3218-472-T001
37 to 90	20	1.5	0.06	1000	ACH3218-332-T001
45 to 105	20	1.5	0.06	1000	ACH3218-222-T001
60 to 115	20	1.5	0.06	1000	ACH3218-152-T001
80 to 140	20	1.5	0.06	1000	ACH3218-102-T001
95 to 150	20	1.5	0.06	1000	ACH3218-681-T001
120 to 180	20	1.5	0.06	1000	ACH3218-471-T001
130 to 210	20	1.5	0.06	1000	ACH3218-331-T001
170 to 250	20	1.5	0.06	1000	ACH3218-221-T001
205 to 280	20	1.5	0.06	1000	ACH3218-151-T001
265 to 340	20	1.5	0.06	1000	ACH3218-101-T001
340 to 420	20	1.5	0.06	1000	ACH3218-680-T001
420 to 500	20	1.5	0.06	1000	ACH3218-470-T001
500 to 600	20	1.5	0.06	1000	ACH3218-330-T001
600 to 700	20	1.5	0.06	1000	ACH3218-220-T001

INSERTION LOSS VS. FREQUENCY CHARACTERISTICS

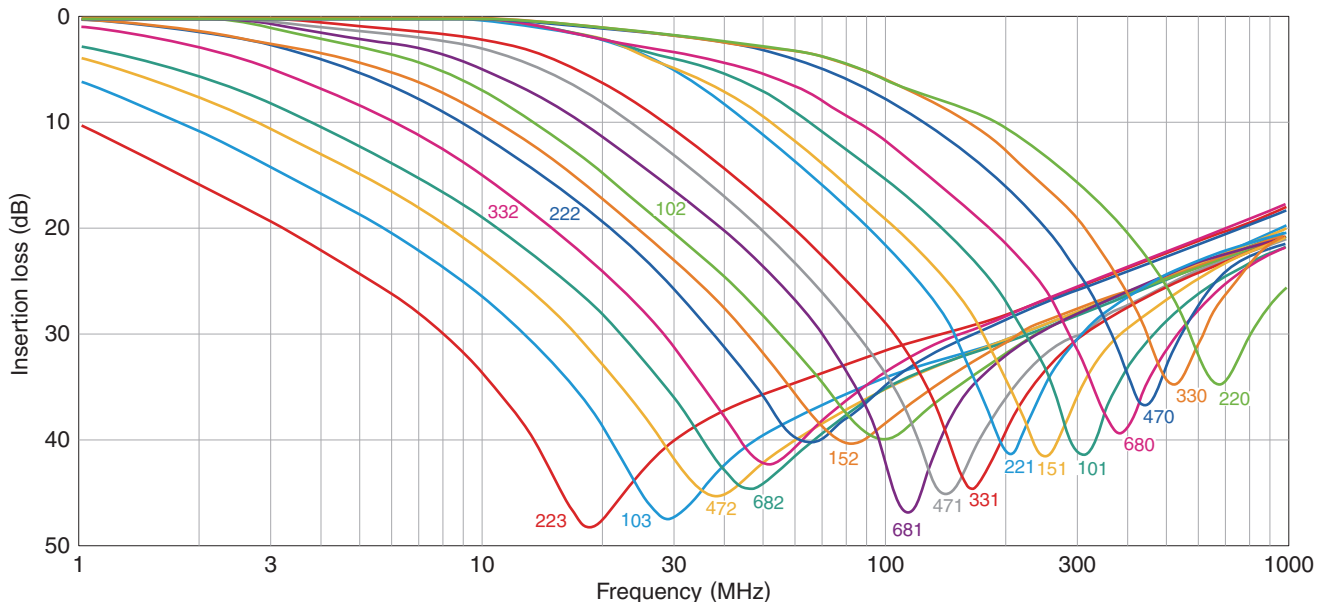

⚠ Please be sure to request delivery specifications that provide further details on the features and specifications of the products for proper and safe use. Please note that the contents may change without any prior notice due to reasons such as upgrading.

ACH3218 type

PACKAGING STYLE

REEL DIMENSIONS

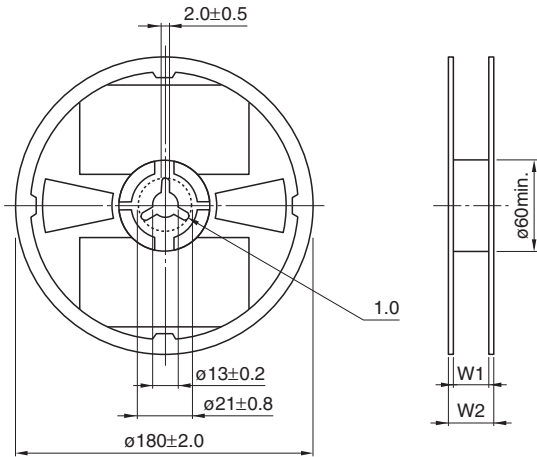

Type	W1	W2
ACH3218	13.0±0.3	17.0±1.4

Dimensions in mm

TAPE DIMENSIONS

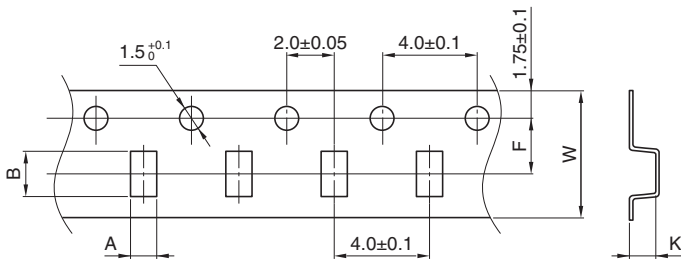

Dimensions in mm

Type	A	B	F	W	K
ACH3218	2.2±0.1	3.65±0.1	5.5±0.05	12.0±0.2	3.0max.

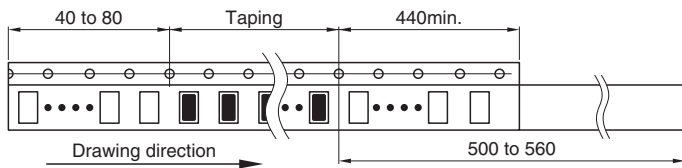

Dimensions in mm

Mouser Electronics

Authorized Distributor

Click to View Pricing, Inventory, Delivery & Lifecycle Information:

TDK:

[ACH3218-470-TD01](#) [ACH3218-330-TD01](#) [ACH3218-220-TD01](#) [ACH3218-103-TD01](#) [ACH3218-681-TD01](#)
[ACH3218-223-TD01](#) [ACH3218-332-TD01](#) [ACH3218-222-TD01](#) [ACH3218-472-TD01](#) [ACH3218-152-TD01](#) [ACH3218-102-TD01](#) [ACH3218-682-TD01](#) [ACH3218-680-TD01](#) [ACH3218-101-TD01](#) [ACH3218-471-TD01](#) [ACH3218-221-TD01](#)
[ACH3218-331-TD01](#) [ACH3218-151-TD01](#)