

## HBT GAIN BLOCK MMIC AMPLIFIER, 7 - 15 GHz

### Typical Applications

The HMC3653LP3BE is ideal for:

- Point-to-Point Radios
- Point-to-Multipoint Radios
- VSAT
- LO Driver for HMC Mixers
- Military EW & ECM

### Functional Diagram

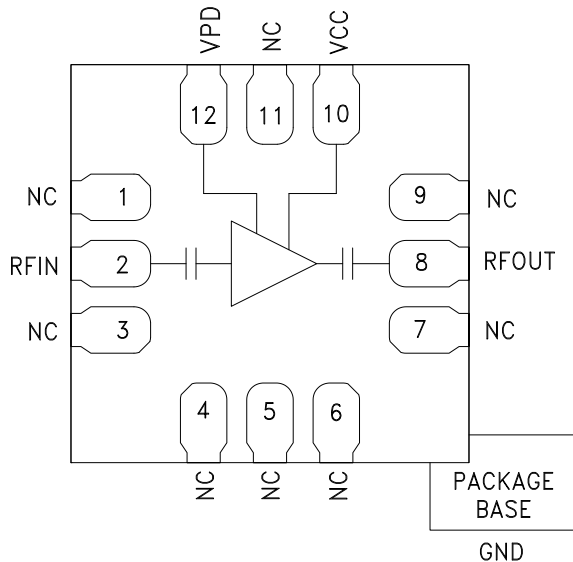

### Features

- High Output IP3: +28 dBm
- Single Positive Supply: +5V
- Low Noise Figure: 4.0 dB <sup>[1]</sup>
- 12 Lead 3x3 mm SMT Package: 9mm<sup>2</sup>

### General Description

The HMC3653LP3BE is a HBT Gain Block MMIC amplifier covering 7 GHz to 15 GHz and packaged in a 3x3 mm plastic QFN SMT package. This versatile amplifier can be used as a cascadable IF or RF gain stage in 50 Ohm applications. The HMC3653LP3BE delivers 15 dB gain, and +15 dBm output P1dB with only 4 dB noise figure.

### Electrical Specifications, $T_A = +25^\circ\text{C}$ , $V_{cc} = 5\text{V}$ , $V_{pd} = 5\text{V}$

Parameter	Min.	Typ.	Max.	Min.	Typ.	Max.	Min.	Typ.	Max.	Units
Frequency Range	7 - 9		9 - 14		14 - 15					
Gain <sup>[1]</sup>	10.5	14		12	15		12	15		dB
Gain Variation Over Temperature		0.016			0.016			0.022		dB / °C
Input Return Loss		14			15			11		dB
Output Return Loss		8			8			7		dB
Output Power for 1 dB Compression (P1dB) <sup>[1]</sup>	13	16		12	15		10.5	13.5		dBm
Output Third Order Intercept (IP3) (Pout = 0 dBm per tone, 1 MHz spacing)		26			28			26		dBm
Noise Figure <sup>[1]</sup>		6			4			4		dB
I <sub>cc</sub> (V <sub>pd</sub> = 5V)		40	55		40	55		40	55	mA
I <sub>cc</sub> (V <sub>pd</sub> = 0V)		4	6		4	6		4	6	mA

[1] Board loss subtracted out

**HBT GAIN BLOCK  
MMIC AMPLIFIER, 7 - 15 GHz**

**Gain & Return Loss**

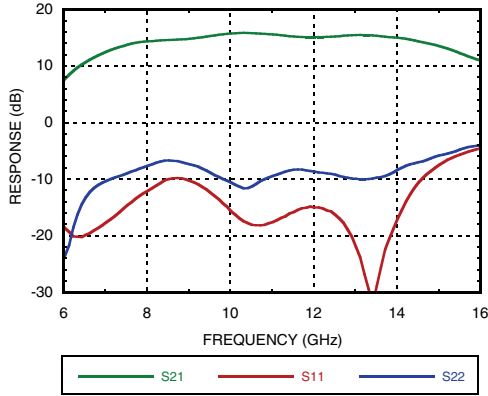

**Gain vs. Temperature**

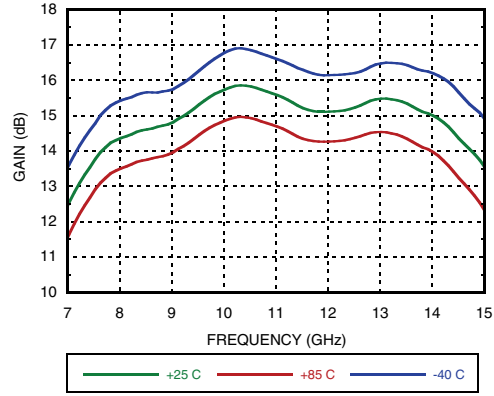

**Input Return Loss vs. Temperature**

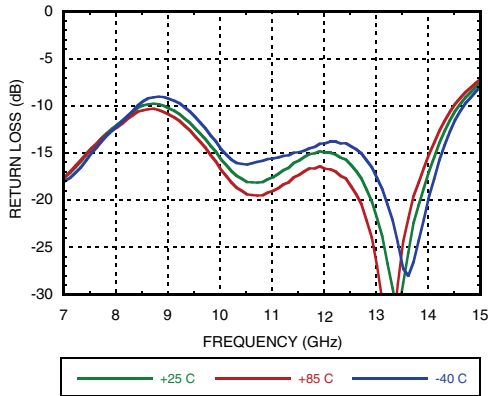

**Output Return Loss vs. Temperature**

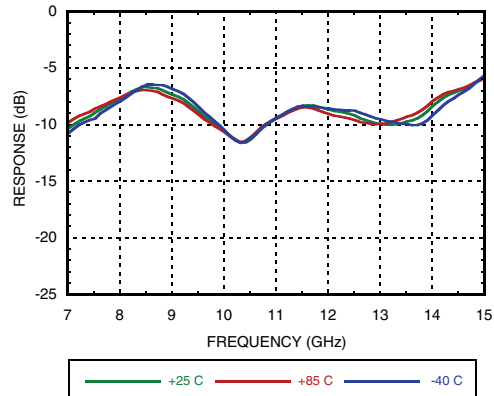

**Noise Figure vs. Temperature**

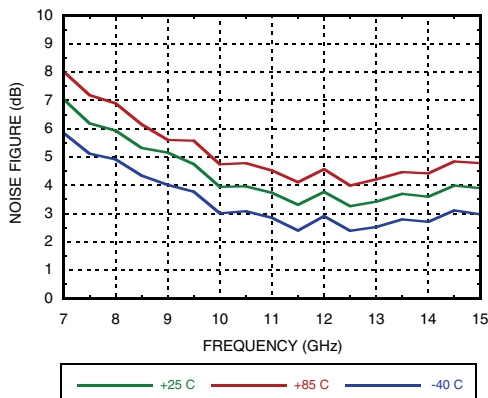

**P1dB vs. Temperature**

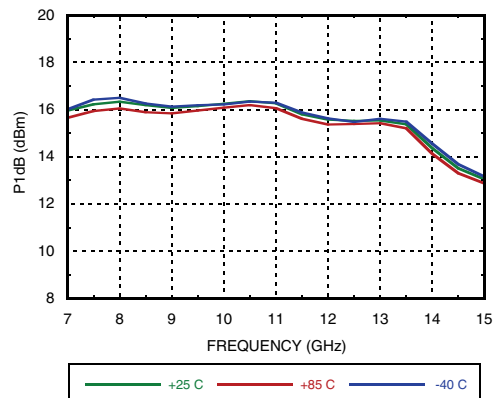

**HBT GAIN BLOCK  
MMIC AMPLIFIER, 7 - 15 GHz**

**Psat vs. Temperature**

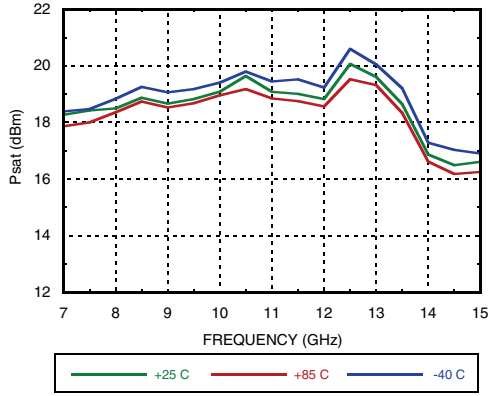

**Output IP3 vs Temperature**

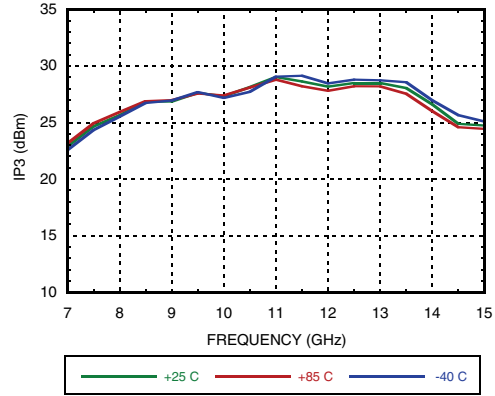

**Phase Noise @ Pin=0 dBm**

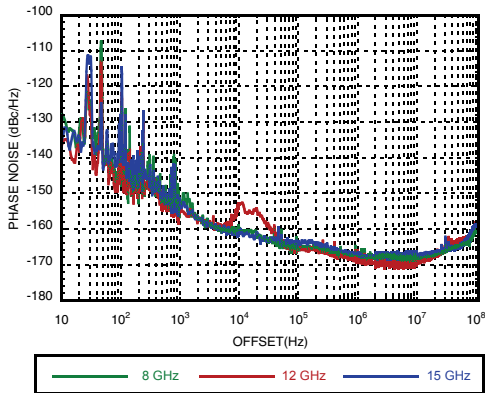

**Power Compression @ 8 GHz**

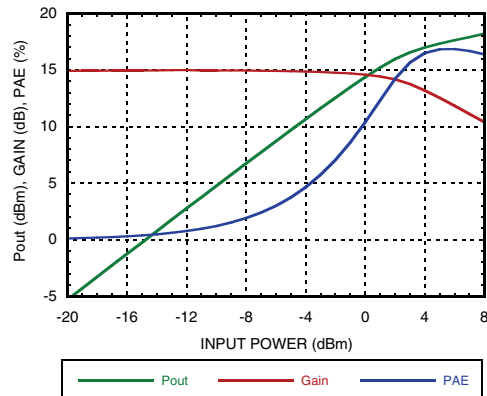

**Power Compression @ 11 GHz**

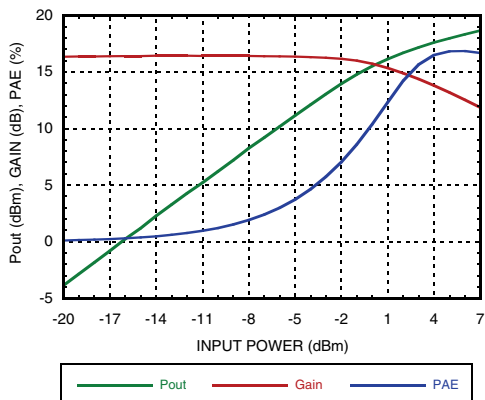

**Power Compression @ 14 GHz**

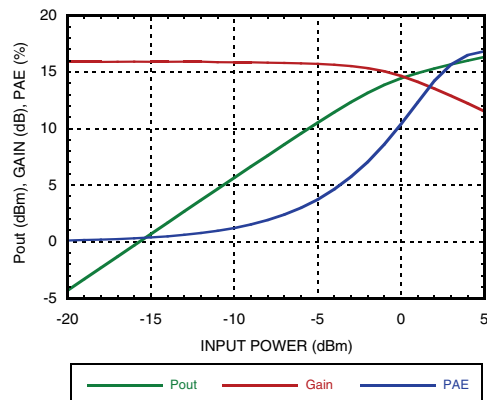

## HBT GAIN BLOCK MMIC AMPLIFIER, 7 - 15 GHz

### Reverse Isolation

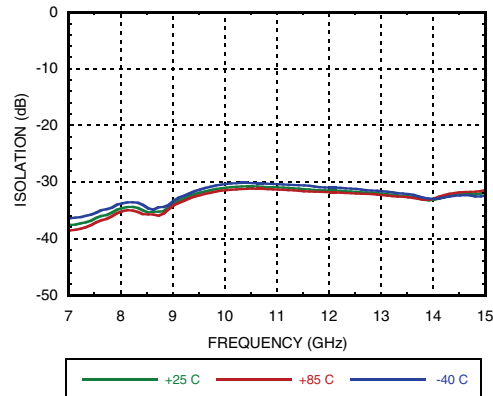

### Absolute Maximum Ratings

Drain Bias Voltage	6 Vdc
RF Input Power (RFIN)	+12 dBm
Channel Temperature	150 °C
Continuous P <sub>diss</sub> (T=85 °C) (derate 7.87 mW/ °C Above +85 °C)	512 mW
Thermal Resistance (channel to ground paddle)	127 °C/W
Storage Temperature	-65 to 150 °C
Operating Temperature	-40 to +85 °C
ESD Sensitivity (HBM)	Class 1A



ELECTROSTATIC SENSITIVE DEVICE  
OBSERVE HANDLING PRECAUTIONS

## HBT GAIN BLOCK MMIC AMPLIFIER, 7 - 15 GHz

### Outline Drawing

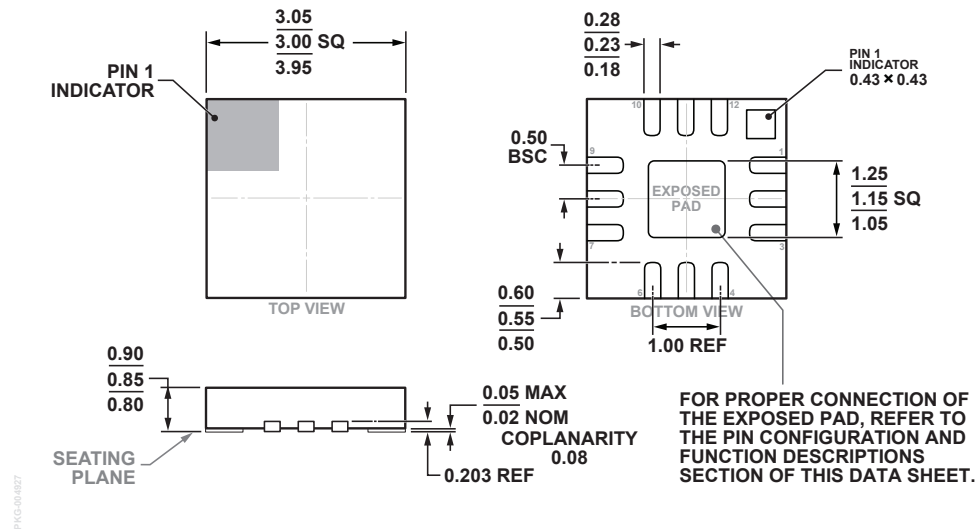

12-Lead Lead Frame Chip Scale Package [LFCSP]  
3 mm × 3 mm Body and 0.85 mm Package Height  
(CP-12-10)

Dimensions shown in millimeters

### Package Information

Part Number	Package Body Material	Lead Finish	MSL Rating [2]	Package Marking [1]
HMC3653LP3BE	RoHS-compliant Low Stress Injection Molded Plastic	100% matte Sn	MSL1	H3653 XXXX

[1] 4-Digit lot number XXXX

[2] Max peak reflow temperature of 260 °C

## HBT GAIN BLOCK MMIC AMPLIFIER, 7 - 15 GHz

### Pin Descriptions

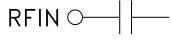
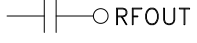
Pid Number	Function	Description	Interface Schematic
1, 3, 4, 5, 6, 7, 9, 11	NC	No connection necessary. These pins may be connected to RF/DC ground. Performance will not be affected.	
2	RFIN	This pin is AC coupled and matched to 50 Ohms.	RFIN ○ —  —
8	RFOUT	This pin is AC coupled and matched to 50 Ohms.	—  — ○ RFOUT
10	Vcc	Power supply voltage for the amplifier	
12	Vpd	Power Control Pin for proper control bias	
GND Paddle	GND	Ground Paddle must be connected to RF/DC ground.	○ GND 



**HBT GAIN BLOCK  
MMIC AMPLIFIER, 7 - 15 GHz**

**Evaluation PCB**

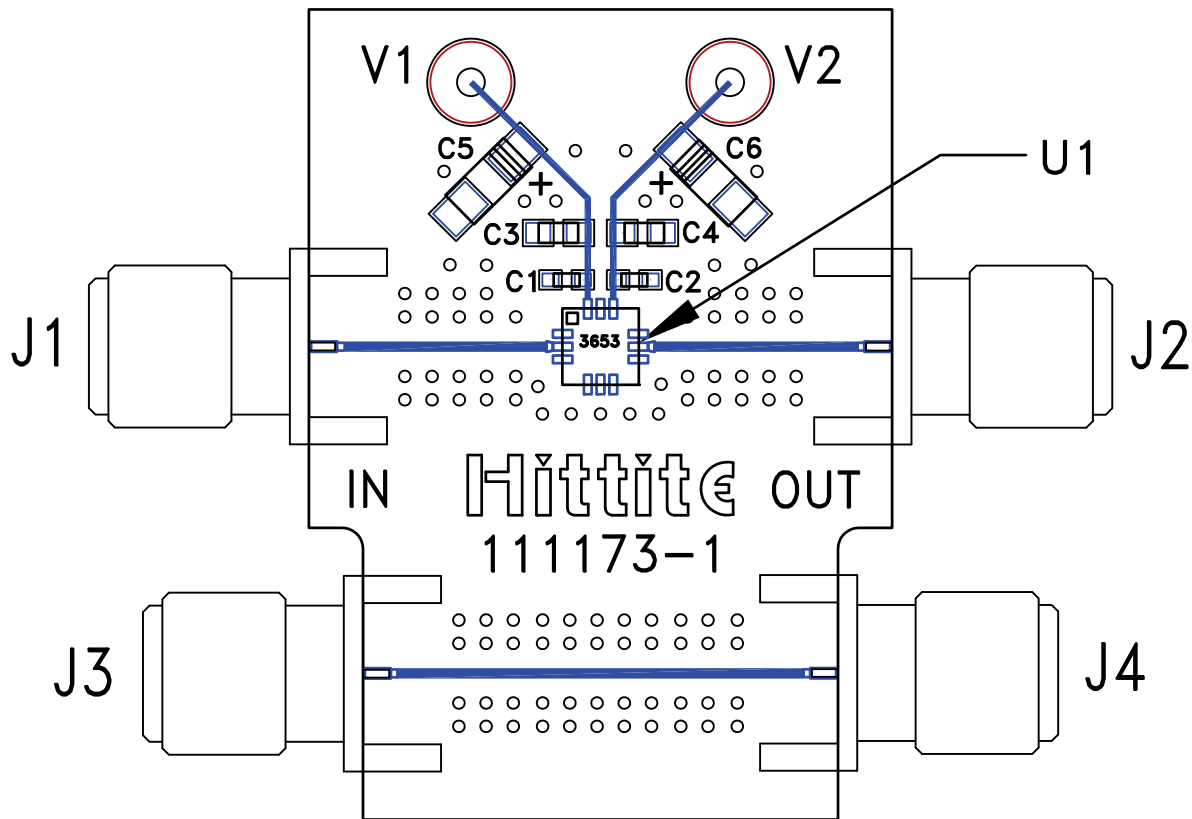

**List of Material for Evaluation PCB 113589-HMC3653LP3B-  
rev D [1]**

Item	Description
J1, J4	PCB Mount SMA RF Connector
C1 - C2	10 pF Capacitor, 0402 Pkg.
C3 - C4	10000 pF Capacitor, 0603 Pkg.
C5 - C6	4.7 uF Capacitor, Tantalum.
U1	HMC3653LP3BE
PCB [2]	111173-1 Evaluation Board

[1] Reference this number when ordering complete evaluation PCB

[2] Circuit Board Material: Rogers 4350 or Arlon 25FR

The circuit board used in the application should use RF circuit design techniques. Signal lines should have 50 Ohm impedance while the package ground leads and exposed paddle should be connected directly to the ground plane similar to that shown. A sufficient number of via holes should be used to connect the top and bottom ground planes. The evaluation circuit board shown is available from Analog Devices upon request.



# Mouser Electronics

Authorized Distributor

Click to View Pricing, Inventory, Delivery & Lifecycle Information:

[Analog Devices Inc.:](#)

[HMC3653LP3BE](#) [113589-HMC3653LP3B](#) [HMC3653LP3BETR](#)