

Specifications

- Current rating:3A AC,DC
- Voltage rating:250V AC,DC
- Temperature range:-40°C~+105°C
- Contact resistance:10mΩMax.
- Insulation resistance:1000MΩMin.
- Withstanding voltage:800V AC/minute
- *Compliant with RoHS and REACH*
- *Meet the HF/Halogen Free,need to customize*
- *Contact CJT for details*

Standards

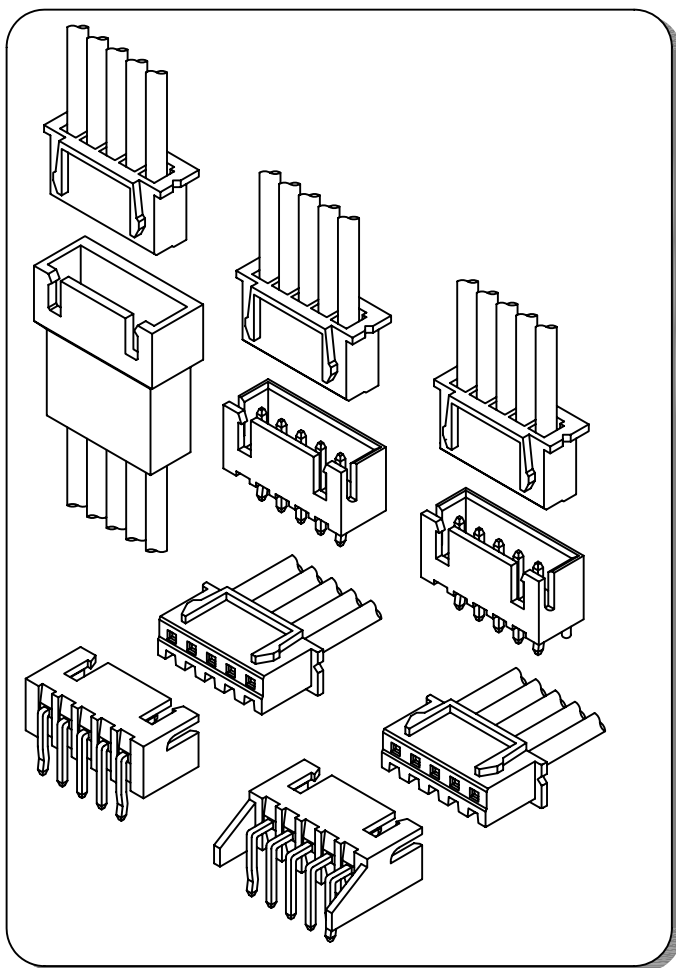

Assembly layout

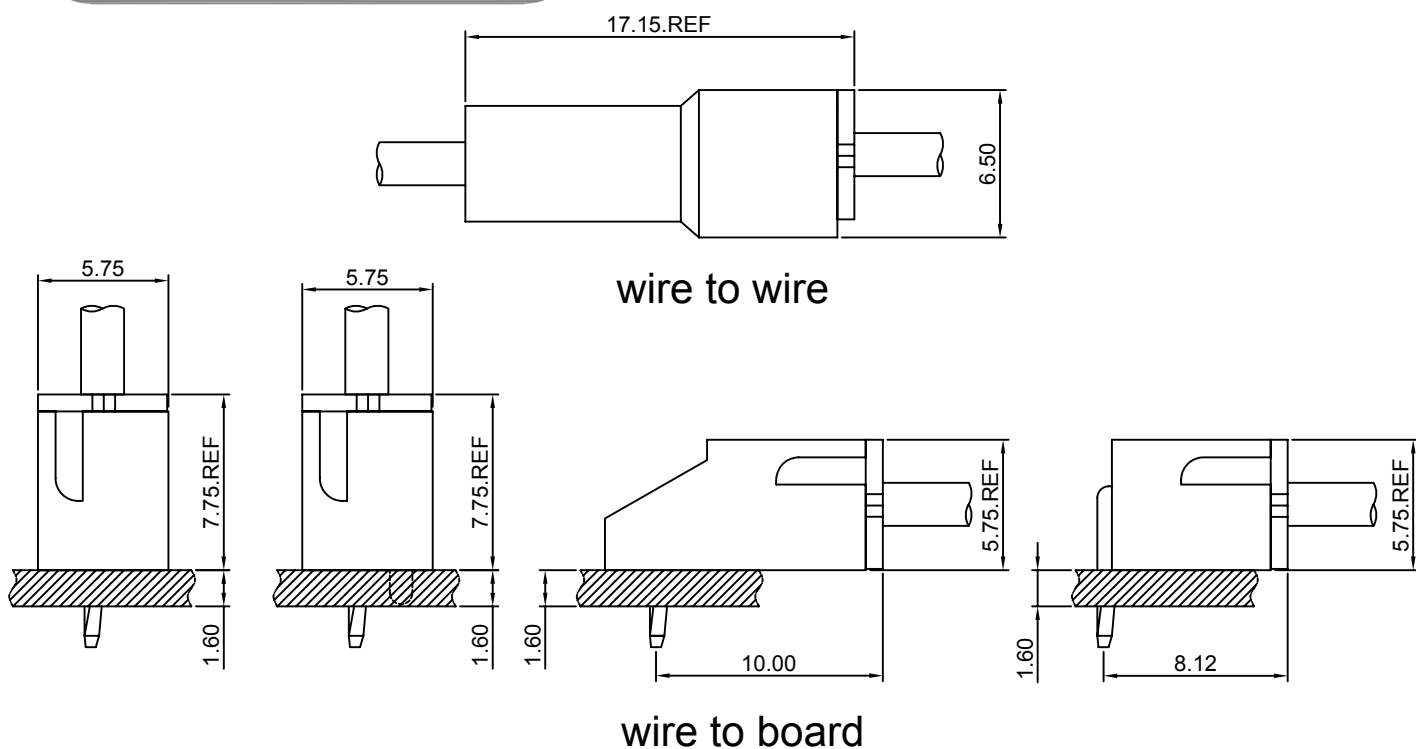

A2501-T

2.50mm pitch Crimp Terminal

Reference Informations:

*Used in CJT A2501 series Housing

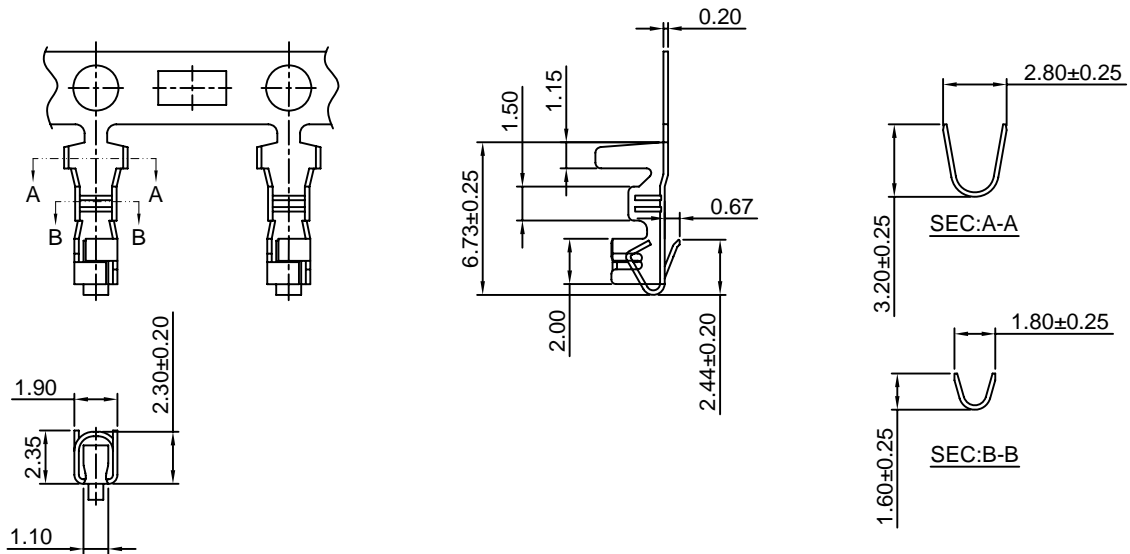

Ordering information & Specifications:

Unit:mm

Part NO.	Wire Range	Insulation O.D.	Material	Finish	Qty/reel
A2501-TP	AWG#22-#28	1.90mm(max)	Phosphor Bronze	Tin over Nickel	8,000 PCS
A2501-GP	AWG#22-#28	1.90mm(max)	Phosphor Bronze	Gold over Nickel	8,000 PCS

Optional Gold plating available but MOQ requested

A2501H

2.50mm pitch Housing

Reference Informations:

- *Material:Nylon 66,UL94V-0
- *Suitable CJT A2501 series Terminal
- *Mates with CJT A2501HMB series Housing or A2501 series Wafer
- *Color: White

Ordering Information:

A2501H-XP - **
1 2

- Part No
- Color:
(blank):White
BL:Blue
BK:Black
RD:Red
YL:Yellow
GN:Green

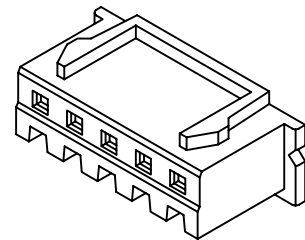

Ordering Information & Dimensions:

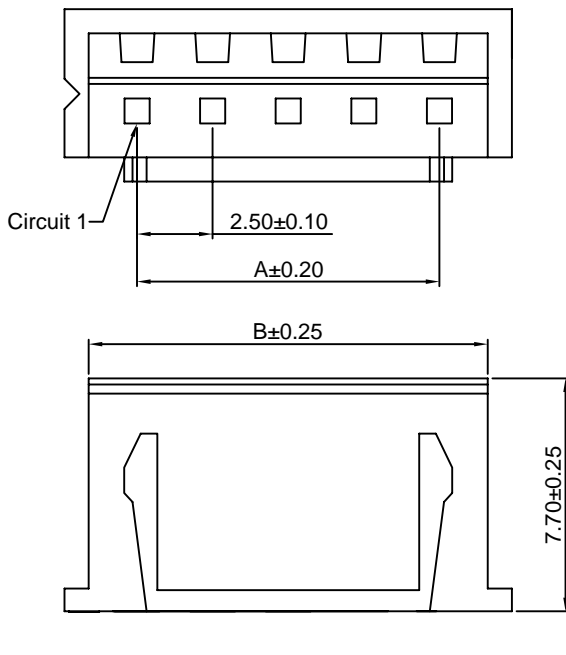

PART NO.	Dimensions	
	A	B
A2501H-2P	2.50	5.70
A2501H-3P	5.00	8.20
A2501H-4P	7.50	10.70
A2501H-5P	10.00	13.20
A2501H-6P	12.50	15.70
A2501H-7P	15.00	18.20
A2501H-8P	17.50	20.70
A2501H-9P	20.00	23.20
A2501H-10P	22.50	25.70
A2501H-11P	25.00	28.20
A2501H-12P	27.50	30.70
A2501H-13P	30.00	33.20
A2501H-14P	32.50	35.70
A2501H-15P	35.00	38.20
A2501H-16P	37.50	40.70
A2501H-17P	40.00	43.20
A2501H-18P	42.50	45.70
A2501H-19P	45.00	48.20
A2501H-20P	47.50	50.70

Unit: mm

A2501HMB

2.50mm pitch Housing

Reference Informations:

- *Material:Nylon 66,UL94V-0
- *Suitable CJT C2504M-T series Terminal
- *Mates with CJT A2501H series Housing
- *Color:White

Ordering Information:

A2501HMB-XP - **
1 2

- Part No
- Color:
(blank):White
BL:Bule
BK:Black
RD:Red
YL:Yellow
GN:Green

Ordering Information & Dimensions:

PART NO.	Dimensions	
	A	B
A2501HMB-2P	2.50	8.70
A2501HMB-3P	5.00	11.20
A2501HMB-4P	7.50	13.70
A2501HMB-5P	10.00	16.20
A2501HMB-6P	12.50	18.70
A2501HMB-7P	15.00	21.20
A2501HMB-8P	17.50	23.70
A2501HMB-9P	20.00	26.20
A2501HMB-10P	22.50	28.70
A2501HMB-11P	25.00	31.20
A2501HMB-12P	27.50	33.70
A2501HMB-13P	30.00	36.20
A2501HMB-14P	32.50	38.70
A2501HMB-15P	35.00	41.20
A2501HMB-16P	37.50	43.70
A2501HMB-17P	40.00	46.20
A2501HMB-18P	42.50	48.70
A2501HMB-19P	45.00	51.20
A2501HMB-20P	47.50	53.70

Unit: mm

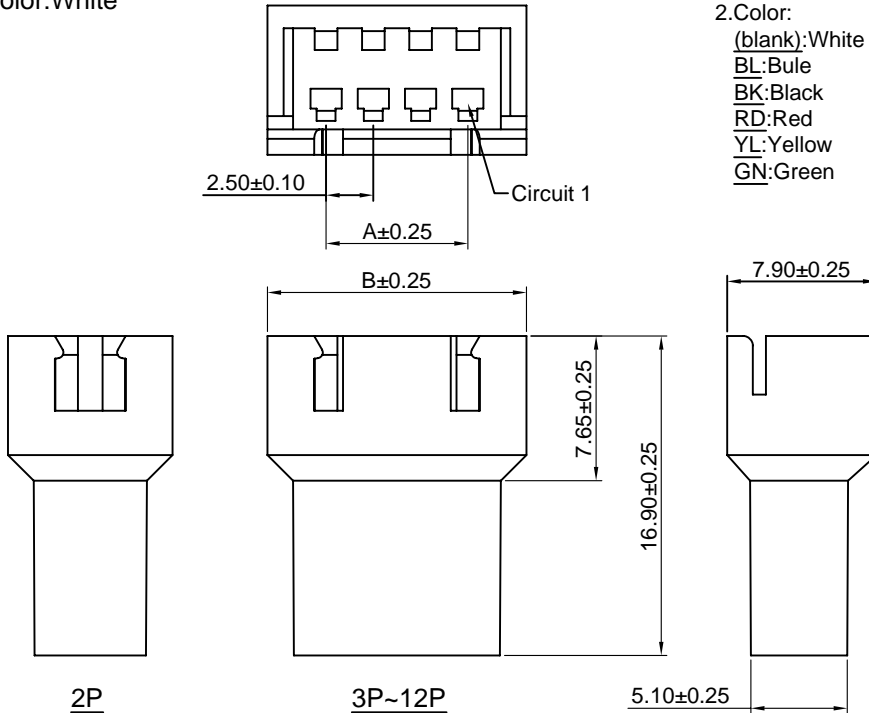

A2501WV

2.50mm pitch 180° Wafer

Reference Informations:

- *Material:Pin:Brass/Tin over Nickel
Insulator:Nylon 66,UL94V-0
- *Mates with CJT A2501 series Housing
- *Color:White

Ordering Information:

A2501WV-XP - * - **
1 2 3

- Part No
- Style:
(blank) :Type 1
2 :Type 2
- Color:
(blank):White
BL:Bule
BK:Black
RD:Red
YL:Yellow
GN:Green

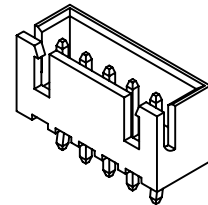

Ordering Information & Dimensions

PART NO.	Dimensions	
	A	B
A2501WV-2P	2.50	7.50
A2501WV-3P	5.00	10.00
A2501WV-4P	7.50	12.50
A2501WV-5P	10.00	15.00
A2501WV-6P	12.50	17.50
A2501WV-7P	15.00	20.00
A2501WV-8P	17.50	22.50
A2501WV-9P	20.00	25.00
A2501WV-10P	22.50	27.50
A2501WV-11P	25.00	30.00
A2501WV-12P	27.50	32.50
A2501WV-13P	30.00	35.00
A2501WV-14P	32.50	37.50
A2501WV-15P	35.00	40.00
A2501WV-16P	37.50	42.50
A2501WV-17P	40.00	45.00
A2501WV-18P	42.50	47.50
A2501WV-19P	45.00	50.00
A2501WV-20P	47.50	52.50

Unit: mm

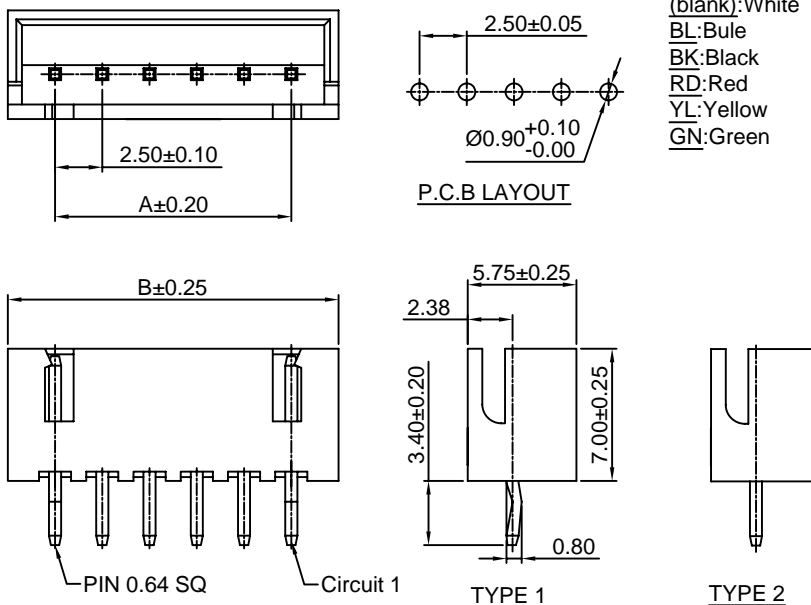

A2501WV-F

2.50mm pitch 180° Wafer - With Boss

Reference Informations:

- *Material: Pin: Brass/Tin over Nickel
Insulator: Nylon 66, UL94V-0
- *Mates with CJT A2501 series Housing
- *Color: White

Ordering Information:

A2501WV-F-XP - **
1 2

- Part No
- Color:
(blank): White
BL: Blue
BK: Black
RD: Red
YL: Yellow
GN: Green

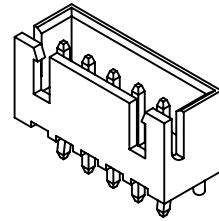

Ordering Information & Dimensions:

PART NO.	Dimensions	
	A	B
A2501WV-F-2P	2.50	7.50
A2501WV-F-3P	5.00	10.00
A2501WV-F-4P	7.50	12.50
A2501WV-F-5P	10.00	15.00
A2501WV-F-6P	12.50	17.50
A2501WV-F-7P	15.00	20.00
A2501WV-F-8P	17.50	22.50
A2501WV-F-9P	20.00	25.00
A2501WV-F-10P	22.50	27.50
A2501WV-F-11P	25.00	30.00
A2501WV-F-12P	27.50	32.50
A2501WV-F-13P	30.00	35.00
A2501WV-F-14P	32.50	37.50
A2501WV-F-15P	35.00	40.00
A2501WV-F-16P	37.50	42.50
A2501WV-F-17P	40.00	45.00
A2501WV-F-18P	42.50	47.50
A2501WV-F-19P	45.00	50.00
A2501WV-F-20P	47.50	52.50

Unit: mm

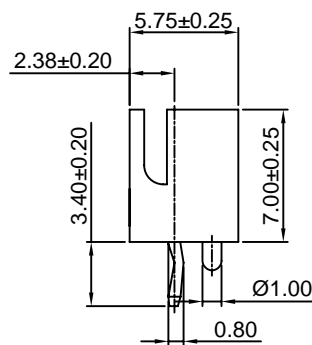
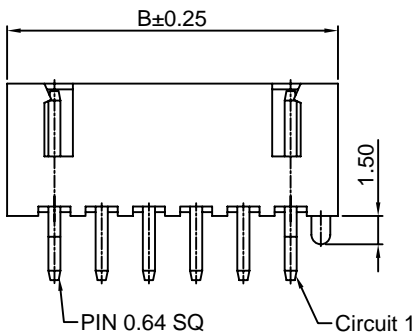
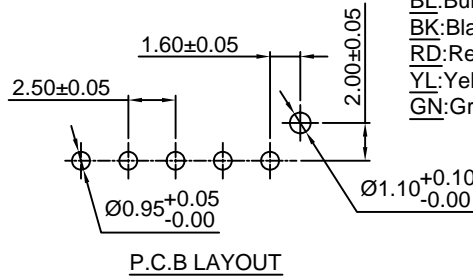
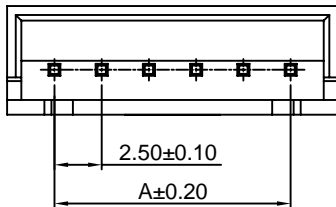

A2501WR

2.50mm pitch 90° Wafer

Reference Informations:

- *Material: Pin: Brass/Tin over Nickel
Insulator: Nylon 66, UL94V-0
- *Mates with CJT A2501 series Housing
- *Color: White

Ordering Information:

A2501WR-XP - ** - **
1 2 3

- Part No
- Style:
(blank): Type 1
2: Type 2
- Color:
(blank): White
BL: Blue
BK: Black
RD: Red
YL: Yellow
GN: Green

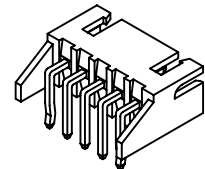
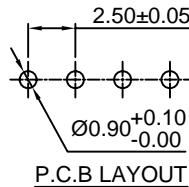

Ordering Information & Dimensions:

PART NO.	Dimensions	
	A	B
A2501WR-2P	2.50	7.50
A2501WR-3P	5.00	10.00
A2501WR-4P	7.50	12.50
A2501WR-5P	10.00	15.00
A2501WR-6P	12.50	17.50
A2501WR-7P	15.00	20.00
A2501WR-8P	17.50	22.50
A2501WR-9P	20.00	25.00
A2501WR-10P	22.50	27.50
A2501WR-11P	25.00	30.00
A2501WR-12P	27.50	32.50
A2501WR-13P	30.00	35.00
A2501WR-14P	32.50	37.50
A2501WR-15P	35.00	40.00
A2501WR-16P	37.50	42.50
A2501WR-17P	40.00	45.00
A2501WR-18P	42.50	47.50
A2501WR-19P	45.00	50.00
A2501WR-20P	47.50	52.50

Unit: mm

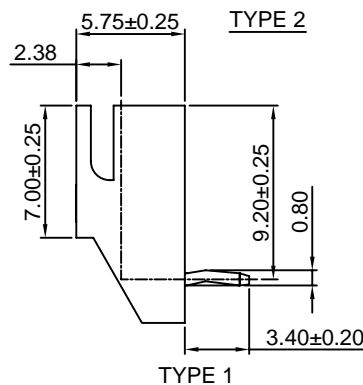
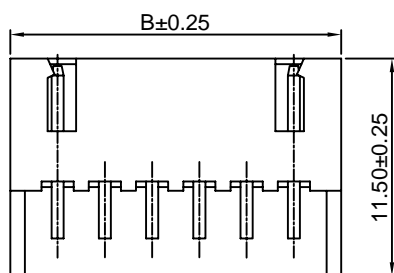
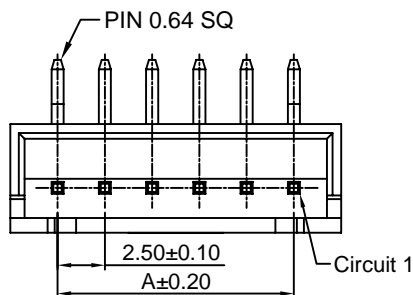

A2501WRB

2.5mm pitch 90° Wafer

Reference Informations:

- *Material: Pin: Brass/Tin over Nickel
Insulator: Nylon 66, UL94V-0
- *Mates with CJT A2501 series Housing
- *Color: White

Ordering Information:
A2501WRB-XP - ** - **
1 2 3

1. Part No
2. Style:
(blank) : Type 1
2 : Type 2
3. Color:
(blank): White
BL: Blue
BK: Black
RD: Red
YL: Yellow
GN: Green

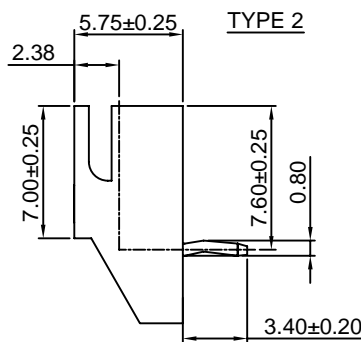
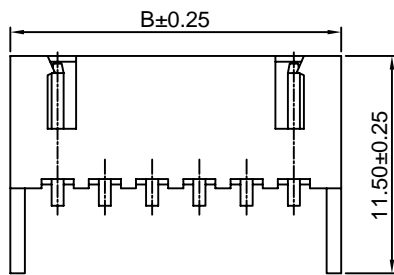
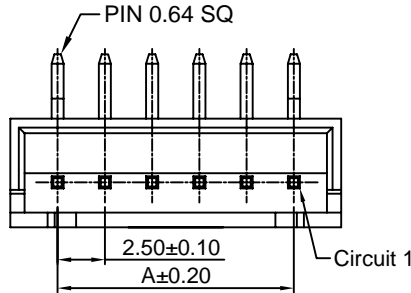
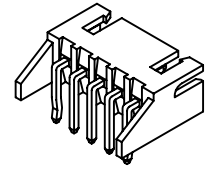
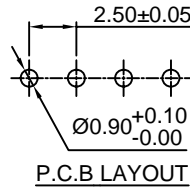

TYPE 1

TYPE 2

Ordering Information & Dimensions:

PART NO.	Dimensions	
	A	B
A2501WRB-2P	2.50	7.50
A2501WRB-3P	5.00	10.00
A2501WRB-4P	7.50	12.50
A2501WRB-5P	10.00	15.00
A2501WRB-6P	12.50	17.50
A2501WRB-7P	15.00	20.00
A2501WRB-8P	17.50	22.50
A2501WRB-9P	20.00	25.00
A2501WRB-10P	22.50	27.50
A2501WRB-11P	25.00	30.00
A2501WRB-12P	27.50	32.50
A2501WRB-13P	30.00	35.00
A2501WRB-14P	32.50	37.50
A2501WRB-15P	35.00	40.00
A2501WRB-16P	37.50	42.50
A2501WRB-17P	40.00	45.00
A2501WRB-18P	42.50	47.50
A2501WRB-19P	45.00	50.00
A2501WRB-20P	47.50	52.50

Unit: mm

A2501WVR

2.5mm pitch 90° Wafer

Reference Informations:

- *Material: Pin: Brass/Tin over Nickel
Insulator: Nylon 66, UL94V-0
- *Mates with CJT A2501 series Housing
- *Color: White

Ordering Information:
A2501WVR-XP - ** - **
1 2 3

1. Part No
2. Style:
(blank) : Type 1
2 : Type 2
3. Color:
(blank): White
BL: Blue
BK: Black
RD: Red
YL: Yellow
GN: Green

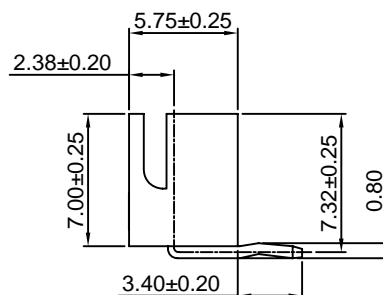
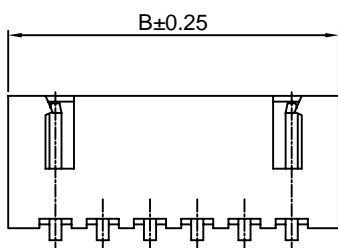
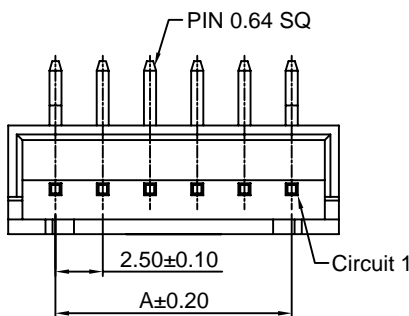
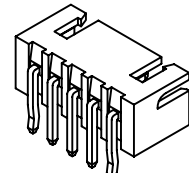
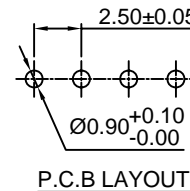

TYPE 1

TYPE 2

Ordering Information & Dimensions:

PART NO.	Dimensions	
	A	B
A2501WVR-2P	2.50	7.50
A2501WVR-3P	5.00	10.00
A2501WVR-4P	7.50	12.50
A2501WVR-5P	10.00	15.00
A2501WVR-6P	12.50	17.50
A2501WVR-7P	15.00	20.00
A2501WVR-8P	17.50	22.50
A2501WVR-9P	20.00	25.00
A2501WVR-10P	22.50	27.50
A2501WVR-11P	25.00	30.00
A2501WVR-12P	27.50	32.50
A2501WVR-13P	30.00	35.00
A2501WVR-14P	32.50	37.50
A2501WVR-15P	35.00	40.00
A2501WVR-16P	37.50	42.50
A2501WVR-17P	40.00	45.00
A2501WVR-18P	42.50	47.50
A2501WVR-19P	45.00	50.00
A2501WVR-20P	47.50	52.50

Unit: mm

A2501WV-S

2.50mm pitch 180° Wafer - SMT TYPE

Reference Informations:

- *Material:Pin:Brass/Tin over Nickel
Solder Tabs:Phosphor Bronze/Tin over Nickel
Insulator:LCP,UL94V-0
- *Mates with CJT A2501 series Housing
- *Color:White

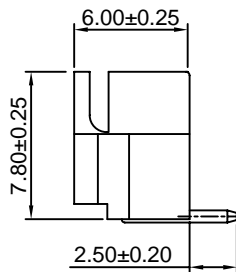
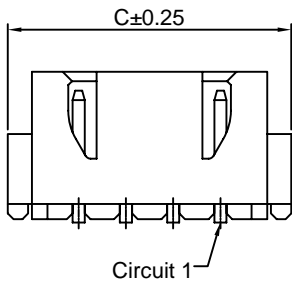
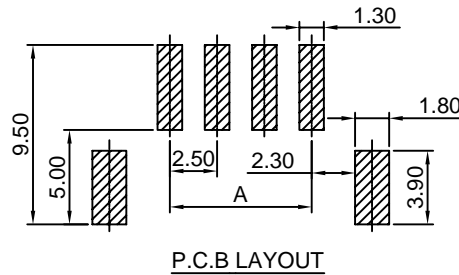
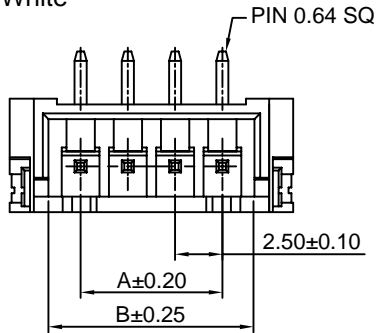
Ordering Information & Dimensions:

PART NO.	Dimensions		
	A	B	C
A2501WV-S-2P	2.50	5.90	10.00
A2501WV-S-3P	5.00	8.40	12.50
A2501WV-S-4P	7.50	10.90	15.00
A2501WV-S-5P	10.00	13.40	17.50
A2501WV-S-6P	12.50	15.90	20.00
A2501WV-S-7P	15.00	18.40	22.50
A2501WV-S-8P	17.50	20.90	25.00
A2501WV-S-9P	20.00	23.40	27.50
A2501WV-S-10P	22.50	25.90	30.00
A2501WV-S-11P	25.00	28.40	32.50
A2501WV-S-12P	27.50	30.90	35.00
A2501WV-S-13P	30.00	33.40	37.50
A2501WV-S-14P	32.50	35.90	40.00
A2501WV-S-15P	35.00	38.40	42.50
A2501WV-S-16P	37.50	40.90	45.00

Unit: mm

A2501WR-S

2.50mm pitch 90° Wafer - SMT TYPE

Reference Informations:

- *Material:Pin:Brass/Tin over Nickel
Insulator:Nylon 6T,UL94V-0
- *Mates with CJT A2501 series Housing
- *Color:White

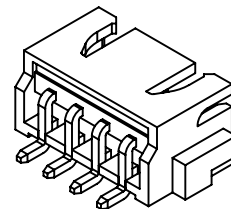
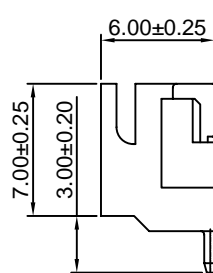
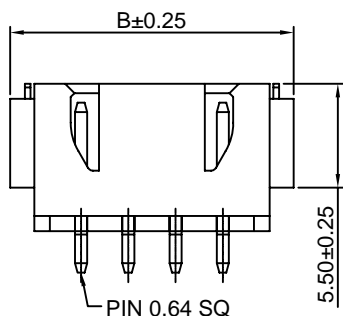
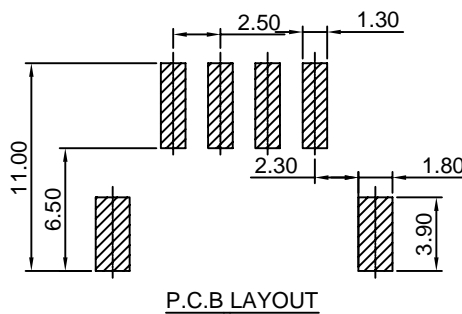
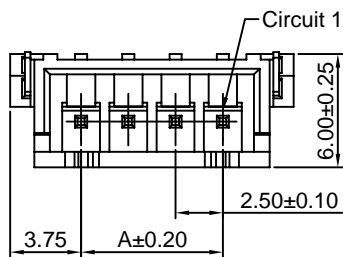
Ordering Information & Dimensions:

PART NO.	Dimensions	
	A	B
A2501WR-S-2P	2.50	10.00
A2501WR-S-3P	5.00	12.50
A2501WR-S-4P	7.50	15.00
A2501WR-S-5P	10.00	17.50
A2501WR-S-6P	12.50	20.00
A2501WR-S-7P	15.00	22.50
A2501WR-S-8P	17.50	25.00
A2501WR-S-9P	20.00	27.50
A2501WR-S-10P	22.50	30.00
A2501WR-S-11P	25.00	32.50
A2501WR-S-12P	27.50	35.00
A2501WR-S-13P	30.00	37.50
A2501WR-S-14P	32.50	40.00
A2501WR-S-15P	35.00	42.50
A2501WR-S-16P	37.50	45.00
A2501WR-S-17P	40.00	47.50
A2501WR-S-18P	42.50	50.00
A2501WR-S-19P	45.00	52.50
A2501WR-S-20P	47.50	55.00

Unit: mm

A2501WRA-S-F-2P

2.50mm pitch 90° Wafer - SMT TYPE

Reference Informations:

*Material:Pin:Copper Alloy/Tin Over Nickel

Insulator:Nylon 9T, UL94V-0

*Color:Ivory

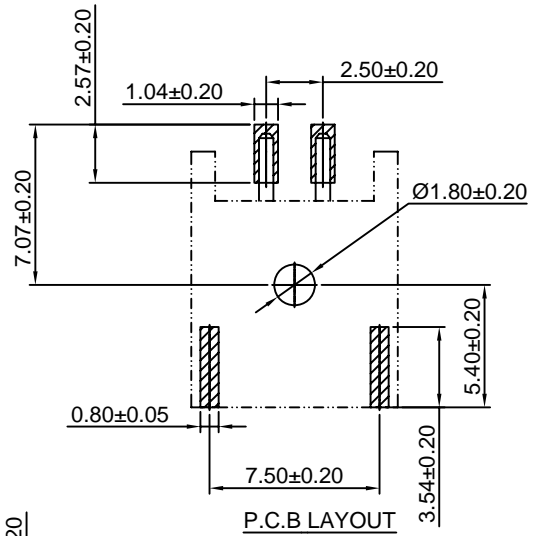
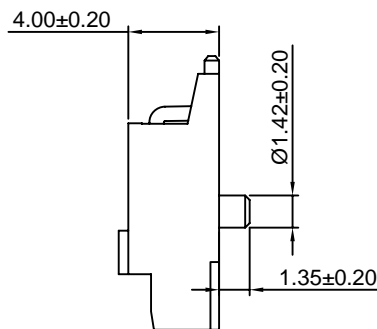
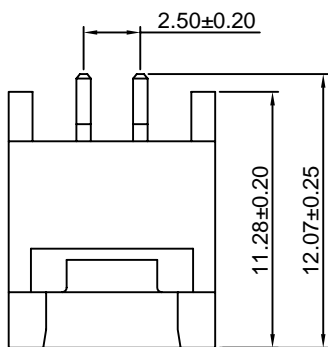
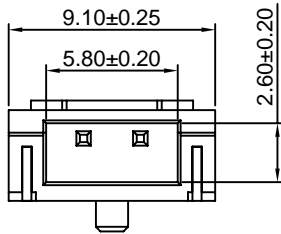

A2501WVT

2.5mm pitch 180° Wafer ON RADIAL-TAPE

Reference Informations:

- *Material: Pin: Brass/Tin over Nickel
Insulator: Nylon66, UL94V-0
- *Mates with CJT A2501H series Housing
- *Color: White

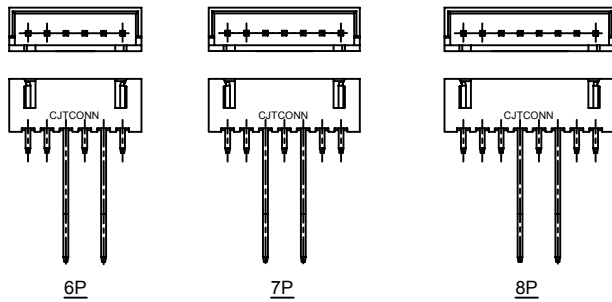
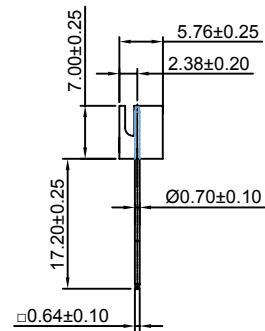
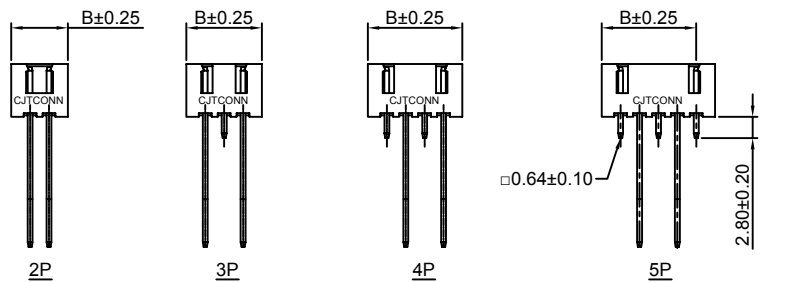
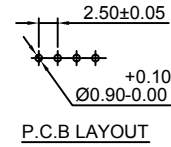
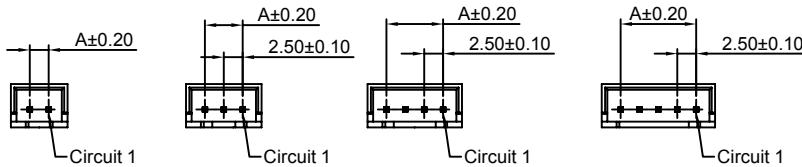
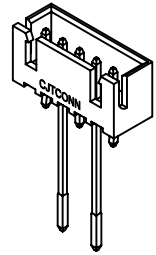

Ordering Information:

A2501WVT-XP - **
1 2

- Part No.
- Color:
(blank): White
BL: Blue
BK: Black
RD: Red
YL: Yellow
GN: Green

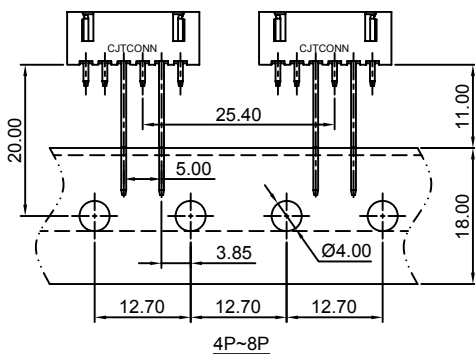
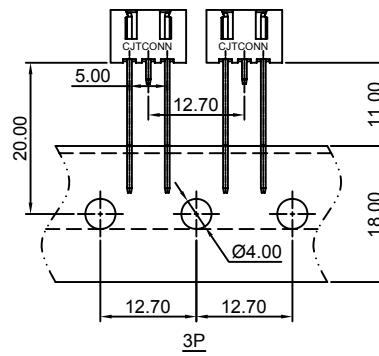
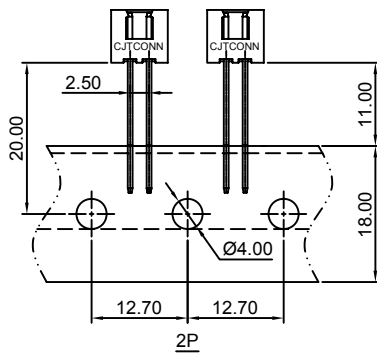

Ordering Information & Dimensions:

PART NO.	Dimensions	
	A	B
A2501WVT-2P	2.50	7.50
A2501WVT-3P	5.00	10.00
A2501WVT-4P	7.50	12.50
A2501WVT-5P	10.00	15.00
A2501WVT-6P	12.50	17.50
A2501WVT-7P	15.00	20.00
A2501WVT-8P	17.50	22.50

Unit: mm