



# 2SB649/A

## PNP SILICON TRANSISTOR

### BIPOLAR POWER GENERAL PURPOSE TRANSISTOR

■ APPLICATIONS

\* Low frequency power amplifier complementary pair with UTC 2SD669/A

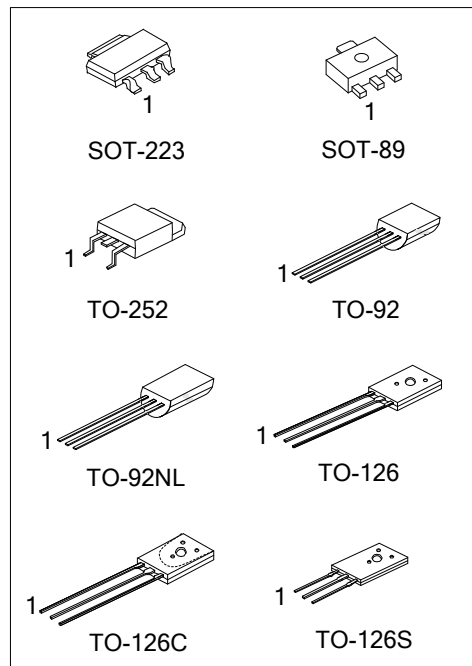

■ ORDERING INFORMATION

Ordering Number		Package	Pin Assignment			Packing
Lead Free	Halogen Free		1	2	3	
-	2SB649xG-x-AA3-R	SOT-223	B	C	E	Tape Reel
-	2SB649xG-x-AB3-R	SOT-89	B	C	E	Tape Reel
2SB649xL-x-TN3-R	2SB649xG-x-TN3-R	TO-252	B	C	E	Tape Reel
2SB649xL-x-T60-K	2SB649xG-x-T60-K	TO-126	E	C	B	Bulk
2SB649xL-x-T6C-K	2SB649xG-x-T6C-K	TO-126C	E	C	B	Bulk
2SB649xL-x-T6S-K	2SB649xG-x-T6S-K	TO-126S	E	C	B	Bulk
2SB649xL-x-T92-B	2SB649xG-x-T92-B	TO-92	E	C	B	Tape Box
2SB649xL-x-T92-K	2SB649xG-x-T92-K	TO-92	E	C	B	Bulk
2SB649xL-x-T9N-B	2SB649xG-x-T9N-B	TO-92NL	E	C	B	Tape Box
2SB649xL-x-T9N-K	2SB649xG-x-T9N-K	TO-92NL	E	C	B	Bulk

Note: Pin Assignment: C: Collector B: Base E: Emitter

<p>2SB649xG-x-AA3-R</p>	<p>(1) B: Tape Box, K: Bulk, R: Tape Reel                  (2) AA3: SOT-223, AB3: SOT-89, TN3: TO-252, T60: TO-126, T6C: TO-126C, T6S: TO-126S, T92: TO-92, T9N: TO-92NL                  (3) x: refer to Classification of <math>h_{FE1}</math>                  (4) G: Halogen Free and Lead Free, L: Lead Free                  (5) A: -160V, Blank: -120V</p>
-------------------------	---

## MARKING

PACKAGE	MARKING	
	2SB649	2SB649A
SOT-223		
SOT-89		
TO-252		
TO-92		
TO-92NL		
TO-126 TO-126C TO-126S		

■ ABSOLUTE MAXIMUM RATINGS (T<sub>A</sub>=25°C, unless otherwise specified)

PARAMETER		SYMBOL	RATING	UNIT
Collector-Base Voltage		V <sub>CB0</sub>	-180	V
Collector-Emitter Voltage	2SB649	V <sub>CEO</sub>	-120	V
	2SB649A		-160	V
Emitter-Base Voltage		V <sub>EBO</sub>	-5	V
Collector Current		I <sub>C</sub>	-1.5	A
Collector Peak Current		I <sub>C(PEAK)</sub>	-3	A
Power Dissipation	SOT-89	P <sub>D</sub>	0.5	W
	SOT-223		1	W
	TO-92/TO-92NL		0.6	W
	TO-126		1	W
	TO-126C/TO-126S		1.3	
	TO-252		2	W
Junction Temperature		T <sub>J</sub>	+150	°C
Storage Temperature		T <sub>STG</sub>	-40 ~ +150	°C

Note: Absolute maximum ratings are those values beyond which the device could be permanently damaged. Absolute maximum ratings are stress ratings only and functional device operation is not implied.

■ THERMAL DATA

PARAMETER		SYMBOL	RATINGS	UNIT
Junction to Case	SOT-89	θ <sub>JC</sub>	38	°C/W
	SOT-223		15	
	TO-92/ TO-92NL		80	
	TO-126		6.25	
	TO-126C/TO-126S		10	
	TO-252		4.5	

■ ELECTRICAL CHARACTERISTICS (T<sub>A</sub>=25°C, unless otherwise specified)

PARAMETER		SYMBOL	TEST CONDITIONS	MIN	TYP	MAX	UNIT
Collector to Base Breakdown Voltage		BV <sub>CB0</sub>	I <sub>C</sub> =-1mA, I <sub>E</sub> =0	-180			V
Collector to Emitter Breakdown Voltage	2SB649	BV <sub>CEO</sub>	I <sub>C</sub> =-10mA, R <sub>BE</sub> =∞	-120			V
	2SB649A			-160			
Emitter to Base Breakdown Voltage		BV <sub>EBO</sub>	I <sub>E</sub> =-1mA, I <sub>C</sub> =0	-5			V
Collector Cut-off Current		I <sub>CB0</sub>	V <sub>CB</sub> =-160V, I <sub>E</sub> =0			-10	μA
DC Current Gain	2SB649	h <sub>FE1</sub>	V <sub>CE</sub> =-5V, I <sub>C</sub> =-150mA (note)	60		320	
		h <sub>FE2</sub>	V <sub>CE</sub> =-5V, I <sub>C</sub> =-500mA (note)	30			
	2SB649A	h <sub>FE1</sub>	V <sub>CE</sub> =-5V, I <sub>C</sub> =-150mA (note)	60		200	
		h <sub>FE2</sub>	V <sub>CE</sub> =-5V, I <sub>C</sub> =-500mA (note)	30			
Collector-Emitter Saturation Voltage		V <sub>CE(SAT)</sub>	I <sub>C</sub> =-600mA, I <sub>B</sub> =-50mA			-1	V
Base-Emitter Voltage		V <sub>BE</sub>	V <sub>CE</sub> =-5V, I <sub>C</sub> =-150mA			-1.5	V
Current Gain Bandwidth Product		f <sub>T</sub>	V <sub>CE</sub> =-5V, I <sub>C</sub> =-150mA		140		MHZ
Output Capacitance		C <sub>ob</sub>	V <sub>CB</sub> =-10V, I <sub>E</sub> =0, f=1MHZ		27		pF

Note: Pulse test.

■ CLASSIFICATION OF h<sub>FE1</sub>

RANGE	RANK		
	B	C	D
2SB649	60-120	100-200	160-320
2SB649A	60-120	100-200	-

## TYPICAL CHARACTERISTICS

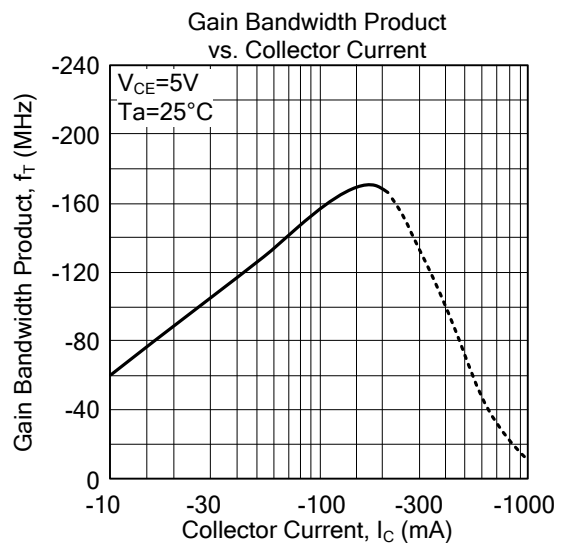
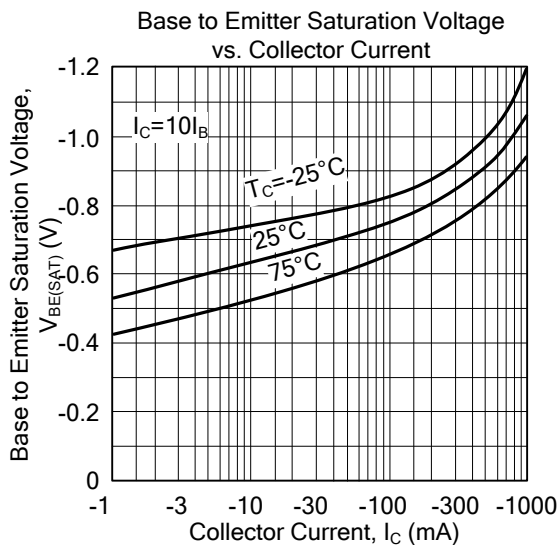
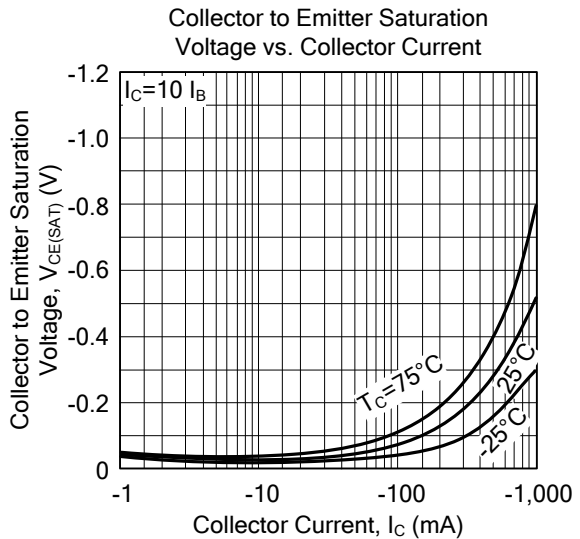
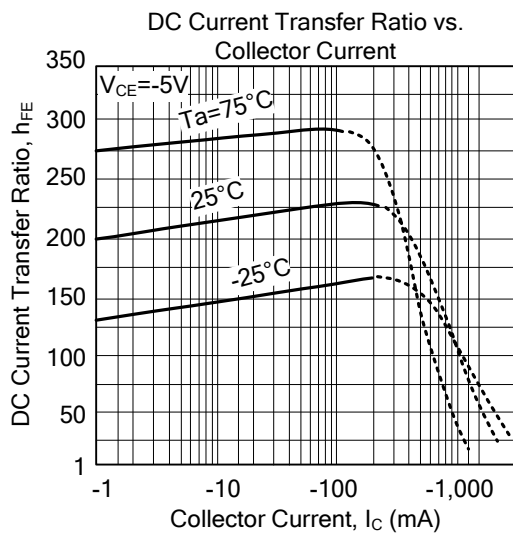
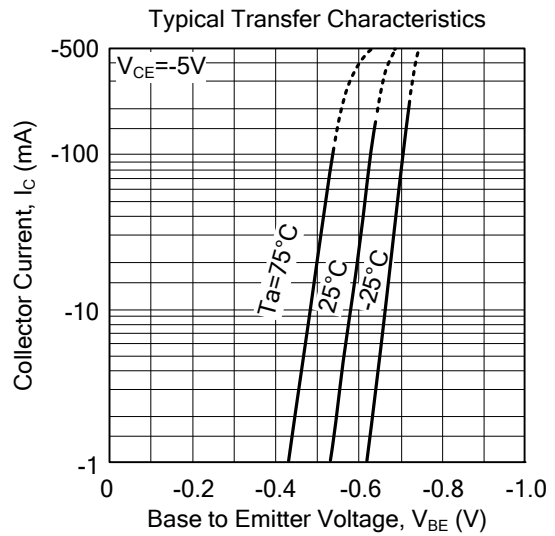
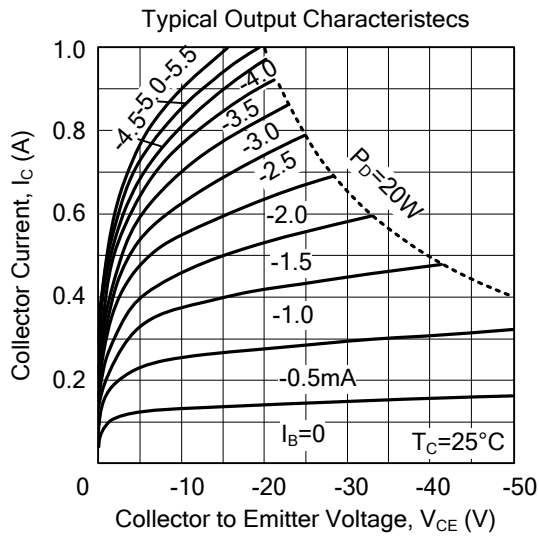

■ TYPICAL CHARACTERISTICS(Cont.)

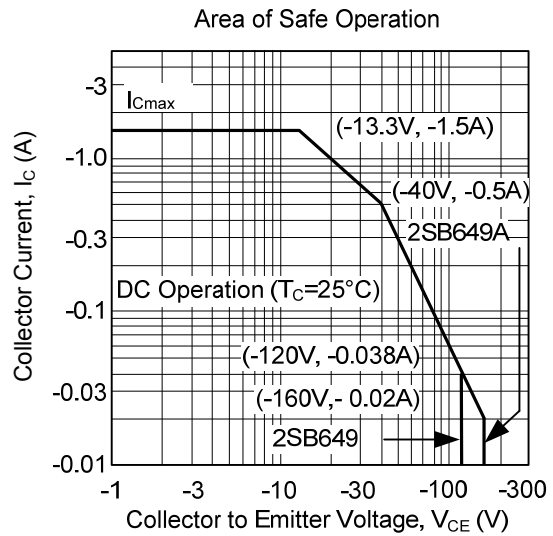
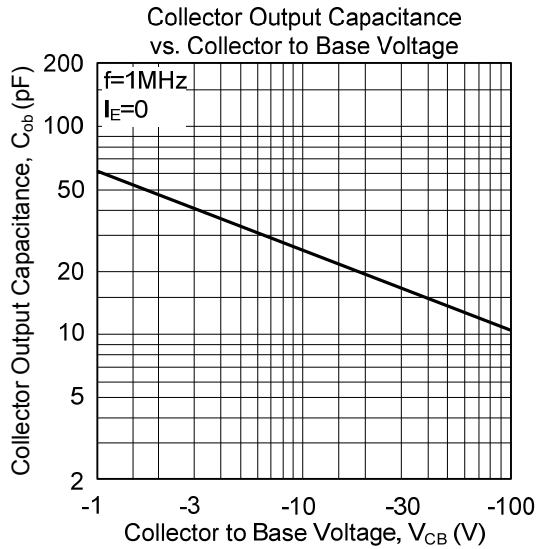

UTC assumes no responsibility for equipment failures that result from using products at values that exceed, even momentarily, rated values (such as maximum ratings, operating condition ranges, or other parameters) listed in products specifications of any and all UTC products described or contained herein. UTC products are not designed for use in life support appliances, devices or systems where malfunction of these products can be reasonably expected to result in personal injury. Reproduction in whole or in part is prohibited without the prior written consent of the copyright owner. The information presented in this document does not form part of any quotation or contract, is believed to be accurate and reliable and may be changed without notice.